



Índice

Index

- 03 Nuestra empresa | *Our company*
- 04 Nuestra historia | *Our history*
- 06 Certificación de calidad ISO 9001:2015 | *ISO 9001:2015 Quality certification*
- 07 ¿Por qué elegirnos? | *Why choose us?*
- 08 Clientes | *Clients*
- 10 Proyectos de Dues Textil en México | *Dues Textil Projects in Mexico*
- 62 Cortinas y cortineros | *Window treatments*
 - 63 Cortinas | *Drapes*
 - 70 Acabados y Sistemas | *Finishes and Systems*
 - 74 Cortineros | *Drapery hardware*
 - 84 Cortineros motorizados | *Motorized drape tracks*
- 89 Sistemas inteligentes | *Intelligent systems*
 - 90 Domótica | *Home automation*
- 92 Decorativos | *Decorative Products*
 - 93 Cubrecamas | *Bed Covers*
 - 94 Fundas de Duvet | *Duvet Covers*
 - 95 Colchas al caer | *Bedspreads*
 - 97 Cobertores | *Blankets*
 - 99 Frazadas | *Throws*
 - 101 Rodapiés y Cubrebox | *Bed Skirts and Box covers*
 - 102 Cojines decorativos | *Decorative pillows*
 - 105 Almohadones decorativos | *Decorative shams*
- 107 Ropa de cama | *Bed linen*
 - 108 Sábanas | *Bed sheets*
 - 109 Almohadas | *Sleeping pillows*
 - 111 Protectores de almohada | *Pillow protectors*
 - 112 Insertos de duvet | *Duvet inserts*
 - 113 Cubrecolchones capitonados | *Quilted mattress covers*
 - 114 Protectores de colchón impermeable | *Waterproof mattress protectors*
 - 115 Bordados | *Embroidery*
- 119 Toallas | *Towels*
 - 120 La Josefina
 - 121 Foreversoft
 - 122 Lynova
 - 123 Toallas de alberca | *Pool towels*
 - 124 Complementos de baño | *Bathroom complements*
- 125 Mantelería | *Table linen*
- 129 Responsabilidad social | *Social responsibility*



Certificación de calidad ISO 9001:2015

ISO 9001:2015 Quality certification

Somos una empresa preocupada por cumplir con los más altos estándares de calidad en todos nuestros procesos; desde la producción y confección de nuestros productos, hasta su entrega y/o instalación.

Desde el año 2012 contamos con la certificación ISO 9001:2008 por parte de la empresa certificadora IQS, misma que a partir del año 2018 nos otorga la certificación ISO 9001:2015.

Este logro refleja nuestro compromiso para garantizar la mejora constante de nuestros procesos, productos y servicios con el único objetivo de ofrecer a nuestros clientes la mejor experiencia de compra.

One of our main concerns is meeting the highest quality standards in all of our processes; from the manufacturing of our products, all the way to their delivery and/or installation.

Since 2012, we have been certified with the ISO 9001:2008 Quality management standard. As of 2018, we obtained the ISO 9001:2015 Quality management standard.

This accomplishment reflects our commitment to ensuring the constant improvement of our management process, products and services with the sole objective of providing our customers with the best purchasing experience possible.



¿Por qué elegirnos?

Why choose us?



Confianza | *Customer Satisfaction*

Nuestra experiencia, infraestructura y personal altamente calificado aseguran la entrega de nuestros productos en tiempo y forma.

Our expertise, infrastructure and highly qualified personnel guarantee a safe and timely delivery.



Garantía | *Guarantee*

Todos nuestros productos tienen garantía limitada contra defectos de fabricación.

All our products have a limited warranty against fabrication defects.



Seguridad | *Security*

Somos pioneros y especialistas en tejidos retardantes al fuego que cumplen normas internacionales como NFPA-701 y Class-1.

We are pioneers and specialists in flame retardant fabrics that comply with international norms such as: NFPA-701 and Class-1.



Innovación | *Innovation*

Nuestros productos, sistemas, equipo y maquinaria son de última generación.

We are committed to state of the art products, systems, equipment and machinery.



Personalización | *Personalization*

Nos adaptamos a las necesidades específicas de nuestros clientes. Podemos crear textiles confeccionados con requerimientos específicos.

We adjust to our customer's specific needs. We produce tailor made products with specific requirements.

Cientes

Clients

En Dues textil vestimos a las marcas de hoteles más reconocidas en el mundo. Con más de 20 años de experiencia somos una empresa líder en la confección de productos textiles en México.

At Dues Textil, we dress the most recognized hotel brands in the world. With over 20 years of experience, we are a leading company in the manufacturing of textile products in Mexico.





Solaz Los Cabos Luxury Resort

San José del Cabo, México

Best Hotel Architecture Mexico



PUNTA DE MITA



Proyectos de Dues Textil en México.

Dues Textil projects in Mexico.





THE RITZ-CARLTON®

The Ritz Carlton CDMX
Ciudad de México





WALDORF ASTORIA
HOTELS & RESORTS

Waldorf Astoria Los Cabos Pedregal
Los Cabos, México





WALDORF ASTORIA
HOTELS & RESORTS

Waldorf Astoria Cancún
Cancún, México





- Best Hotel Architecture Mexico



Solaz Los Cabos Luxury Resort
San José del Cabo, México



- Best Hotel Architecture Mexico





The Residences at Solaz Los Cabos Luxury Resort
San José del Cabo, México





The St. Regis Los Cabos Resort
Los Cabos, México





The St. Regis Punta Mita Resort
Punta de Mita, México





Soho House Mexico City
Ciudad de México, México

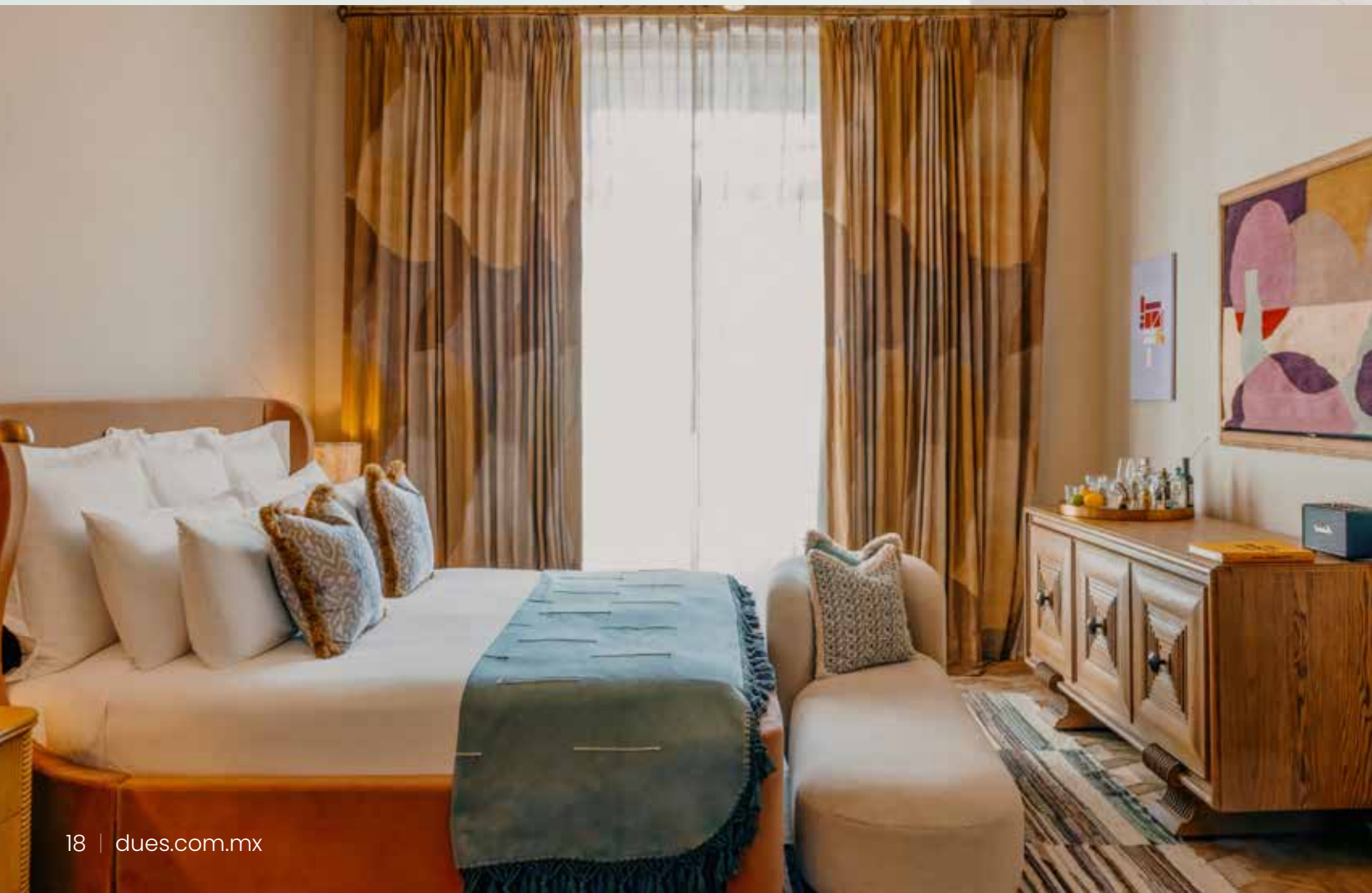



CONRAD
HOTELS & RESORTS™

Conrad Tulum Riviera Maya Resort
Tulum, México





CONRAD Hotels & Resorts™ *Conrad Punta de Mita*
Punta de Mita, México





HYATT
REGENCY

Hyatt Regency Andares
Guadalajara, México





Hyatt Ziva
Cancún y Puerto Vallarta, México





W Hotel Punta Mita
Punta de Mita, México





Hilton

*Hilton Tulum All-Inclusive Resort
Tulum, México*





LIVE
AQUA®
RESORTS & RESIDENCE CLUB

Live Aqua Urban Resort San Miguel de Allende
San Miguel de Allende, México



- Best Hotel Architecture North America, 2019
The World Architecture and Design Award





LIVE
AQUA®
RESORTS & RESIDENCE CLUB

Live Aqua Beach Resort Cancún
Cancún, México





LIVE
AQUA®
RESORTS & RESIDENCE CLUB

Live Aqua Urban Resort Monterrey
Monterrey, México





ROSEWOOD
MAYAKOBA

Rosewood Mayakoba
Playa del Carmen, México





BANYAN TREE
HOTELS & RESORTS

Banyan Tree Mayakoba *Playa del Carmen, México*





Secrets Playa Blanca Costa Mujeres
Costa Mujeres, México.





SECRETS
Akumal
RIVIERA MAYA

Secrets Akumal
Riviera Maya, México





Secrets Maroma Beach
Riviera Maya, México





Secrets Puerto Los Cabos
San José del Cabo, México





Dreams Riviera Resort & Spa
Riviera Maya, México





PUEBLO BONITO
MAZATLÁN
ZONA DORADA

Pueblo Bonito Sábalo
Mazatlán, México





PUEBLO BONITO
MONTECRISTO ESTATES[®]
LUXURY VILLAS

Montecristo Estates Luxury Villas
Cabo San Lucas, México





Pueblo Bonito Sunset Beach Golf & Spa Resort
Cabo San Lucas, México





PUEBLO BONITO
ROSÉ
CABO SAN LUCAS

Pueblo Bonito Rose Beach Resorts
Cabo San Lucas, México





Pueblo Bonito Pacífica
Cabo San Lucas, México





*Pueblo Bonito Emerald Bay
Mazatlán, Sinaloa, México*





Novaispania
BY PUEBLO BONITO

Novaispania at Quivira by Pueblo Bonito
Cabo San Lucas, México





ROYAL HIDEAWAY
LUXURY HOTELS & RESORTS

Royal Hideaway Playacar
Playa del Carmen, México





Grand Fiesta Americana
Monterrey, Chapultepec, México





Fiesta Americana
Monterrey, Hermosillo, Guadalajara y Tlalnepantla, México





Royalton
Luxury Resorts

Royalton Riviera Cancún
Riviera Maya, México





Grand Palladium Costa Mujeres, Kantenah y Vallarta Resorts
Playa Mujeres, Riviera Maya y Riviera Nayarit, México





PARADISUS

Cancun • Mexico

Paradisus Playa del Carmen y La Perla Adults Resort
Playa del Carmen, México





Grand Solmar at Rancho San Lucas
Cabo San Lucas, México





VENTUS
AT MARINA EL CID
Spa & Beach Resort | Cancún Riviera Maya

*Ventus At Marina el Cid
Puerto Morelos, Quintana Roo, México*





El Cid Resorts
Mazatlán, Riviera Maya y Puerto Morelos, México





Villa del Palmar at the Island Loreto, México

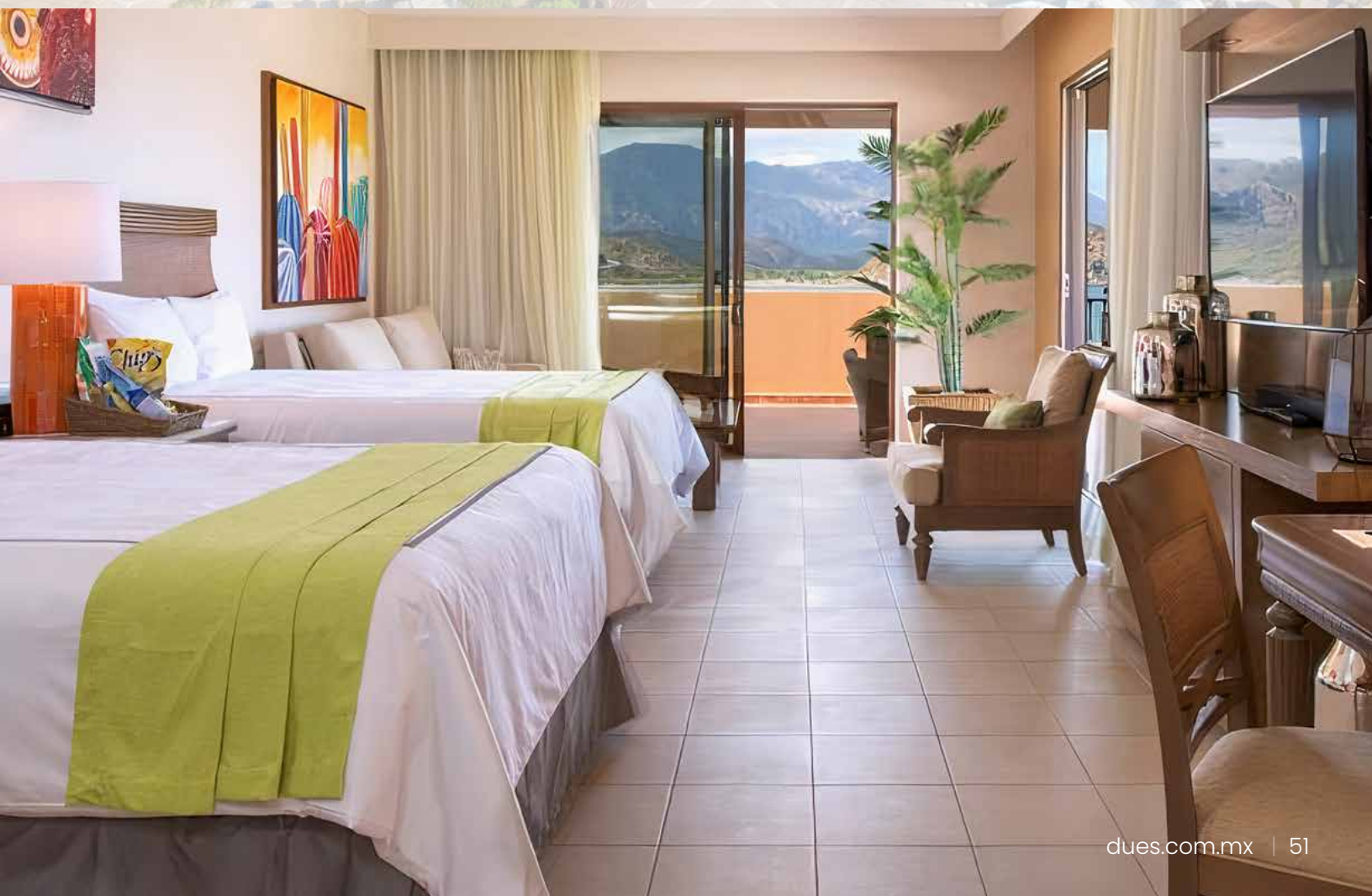



AMOR
ARENAL

Amor Arenal
Fortuna, Costa Rica.





mahekal
beach resort

Mahekal Beach Resort
Playa del Carmen, México





Estrella del Mar

Estrella del Mar
Mazatlán, México





HACIENDA DEL MAR LOS CABOS
RESORT, VILLAS & GOLF

Hacienda del Mar Los Cabos
Cabo San Lucas, México





Hampton Inn by Hilton
Villahermosa, Mérida y Monterrey, México





Marriott
Guadalajara, Culiacán, Mexico.





COURTYARD[®] BY MARRIOTT Courtyard by Marriott
Querétaro y Mazatlán





Fairfield
BY MARRIOTT

*Fairfield Inn & Suites by Marriott
San Luis Potosí, México.*





Hilton Garden Inn
Chihuahua en Chihuahua, México.





NOVOTEL
HOTELS & RESORTS

*Novotel World Trade Center
Ciudad de México*





- Guadalajara • Juárez
- Alameda • Monterrey
- Cancún • Querétaro
- Hermosillo • San Luis Potosi
- Aguascalientes • Culiacán
- Chihuahua • Los Mochis
- Irapuato • Tlanepantla
- Mérida • Mazatlán





Cortinas

Drapes

Además de ofrecer privacidad y controlar el ingreso de luz; las cortinas son un elemento decorativo fundamental en cualquier ambiente.

Las cortinas están hechas de telas especiales que ofrecen buen tacto y caída que otorgan a la cortina una mejor apariencia; utilizan pliegues en una amplia variedad de diseños y tamaños.

Son ideales para realzar cualquier espacio, con un estilo casual, contemporáneo o tradicional, dependiendo de la tela y cortinero que se utilice.

In addition to offering privacy and managing the amount of light in a space, custom drapes are a key decorative element for every room.

Our drapes are made of soft good hand materials that have diverse possibilities and are ideal for transforming any space into a contemporary, casual, or traditional setting based on the choices made.

Certificaciones / *Certifications*





Tela Genova Plata

Plitz Francés

Diseño confeccionado con pliegues.

1, 2 o 3 pliegues.

*Aplica con varios factores de plisado.

French Pinch Pleat

Pleat tailored design.

1, 2 or 3 Pleats.

*Applies with various pleating factors.



Tela Noir Flock Avena

Plitz Español

Diseño con pliegues en forma de tablonés.

*Confección sugerida para paneles decorativos y cortinas fijas.

Factor de Plisado:

200% o 250%

Spanish Pleat

Inverted flat pleat design.

**Suggested for decorative panels and fixed drapes.*

Flat pleat design:

200% or 250% Fullness



Tela Lucca Humo

Cortina Sistema Ondulado / Ripplefold Drape

Cada onda se aprecia en ambas vistas de la cortina.

Factor de plisado:
180% o 200%

Each ripple can be seen from both sides of the drape. Whether inside of the room or outside the building.

180% or 200% Fullness

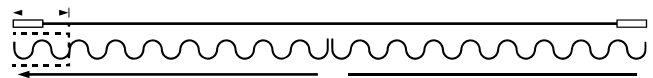

Forma de plisado / Pleat view



Tela Linet Lino

Plitz Portugués

Diseño con pliegues en forma de tabloncitos invertidos.

*Confección sugerida para paneles decorativos y cortinas lisas

Factor de plisado:

200% o 250%

Portuguese Pleat

Inverted flat pleat design.

**Suggested for decorative panels and plain drapes.*

200% or 250% Fullness



Tela Vellum Yute

Cortina de Presillas

Confeccionada con presillas cosidas y reforzadas.

Factor de plisado:

250%

Tab Top Drape

Tabs hang freely from reinforced loops sewn into the top of the curtain.

Flat pleat design:

250% Fullness



Cortina de Ojillos

Con ojillos de 3.81 cm instalada en cortineros tubulares.

Factor de plisado:
250%

Grommet Drape

With a 1 ½" grommet on top of drapes installed on decorative tubular rods.

Flat pleat design:

250% Fullness



Cortina Ondulada Pasabarra

Confección a base de una cinta pasabarra (Transparente de 10 cm).

Factor de plisado:
250%

Forma de plisado / *Pleat view*

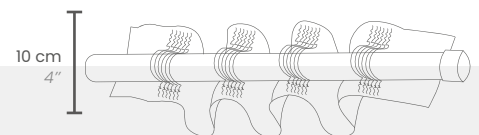

Pocket Pole Drape

Each panel is made with a pocket tape to accommodate a rod or pole.

Flat pleat design:

250% Fullness



Tela Dante Blanco

Cortina Fruncidora Pasabarra

Confección a base de una cinta pasabarra fruncidora de 7.5 cm.

Factor de plisado:
200%

Forma de plisado / Pleat view

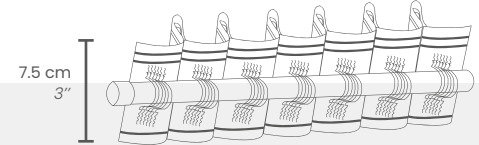

Ruffling Pocket Drape

Each panel is made with a pocket tape to accommodate a rod or pole.

*Flat pleat design:
200% Fullness*



Tela Eitan Gris

Cortina de Visillos

Confeccionada con un dobladillo o bastilla en la parte superior.

Factor de plisado:
200% o 250%

Rod Pocket Drape

Each panel is made with a pocket to accommodate a rod or pole.

*Flat pleat design:
200% or 250% Fullness*



Tela Lucca Lino

Galería Tapizada

Complemento para las cortinas que consta de una base de madera recubierta de hule espuma y tela decorativa.

Vista de 20 cm de altura.

Upholstered Cornice

It adds a touch of elegance to any window. It is made of wood, filling and decorative fabric.

Height view is 8"



Cortina Romana

Combina la belleza de una cortina de tela con el sencillo funcionamiento de una persiana.

A diferencia de la persiana, los lienzos de una cortina romana se pliegan sobre si mismos.

**No se recomienda black out en cortina romana.*

Roman Shade

Also known as Fabric Shade; it combines the beauty of a fabric window treatment with the simple operation of a roller shade.

Roman shades fold up; each unit folds into itself.

**Black out fabric is not recommended for roman shade.*

Acabados y Sistemas

Gancho Dues

Innovador gancho de polipropileno cosido a la cortina, que permite ajustar la altura de la cortina hasta 3 cm.

Se puede lavar y secar en la secadora y es a prueba de rayos UV. Se recomienda para cortinas en Plitz Francés y Español.

Finishes and Systems

Dues Hook

Sewn-in curtain hook, made of high grade polypropylene. It is washable, can be tumble dried and is UV resistant.

It allows for up to 1" adjustment in the height of the drape. It is recommended for usage with French and Spanish Pleat drapes.



Cinta Ripplefold Ripplefold Tape



Cinta Blanca
White Tape

Cinta Negra
Black Tape

Cinta Transparente
Transparent Tape



Bastilla

Confeccionada con altura de 10 cm para todo tipo de cortina.

Bottom Hem

Made with a height of 4" to fit any type of drape.



Festón

Es una costura especial que se utiliza para dar un terminado a la parte inferior de la cortina.

(Recomendado en cortinas decorativas y black out).

Buttonhole Stitch Seam

Is a type of special stitch used to give a finish in the bottom of the drape.

(Recommended for decorative and black out drapes)



Bajo Plomo

Cordón de plomo en la bastilla inferior. Mejora la calidad de la cortina agregando un acabado más uniforme.

(Recomendada para cortina fresca).

Lead Weight Cord

Lead cord sewn into the bottom of the drape, it improves the fall of the curtain by adding a more uniform finish.

(Recommended for sheer curtains).



Forro

Ideal para dar cuerpo uniforme a la cortina y/o bloquear el paso de la luz.

*Se recomienda usar en cortinas de Plitz Francés, Español, Portugués y Ondulada.

*En cortina romana no se recomienda forro black out.

Lining

Ideal to give uniformity to the curtain and or to block the passage of light.

**Recommended for usage with French, Spanish or Portuguese pleat and ripplefold drapes.*

**Black out lining is not recommended for roman shades.*

Stiffener

Permite la colocación del bastón al frente para recorrer la cortina.

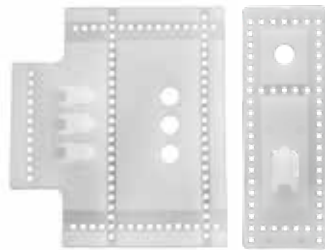

Stiffener

It allows the placement of the baton in front of the curtain in order to open and close it.



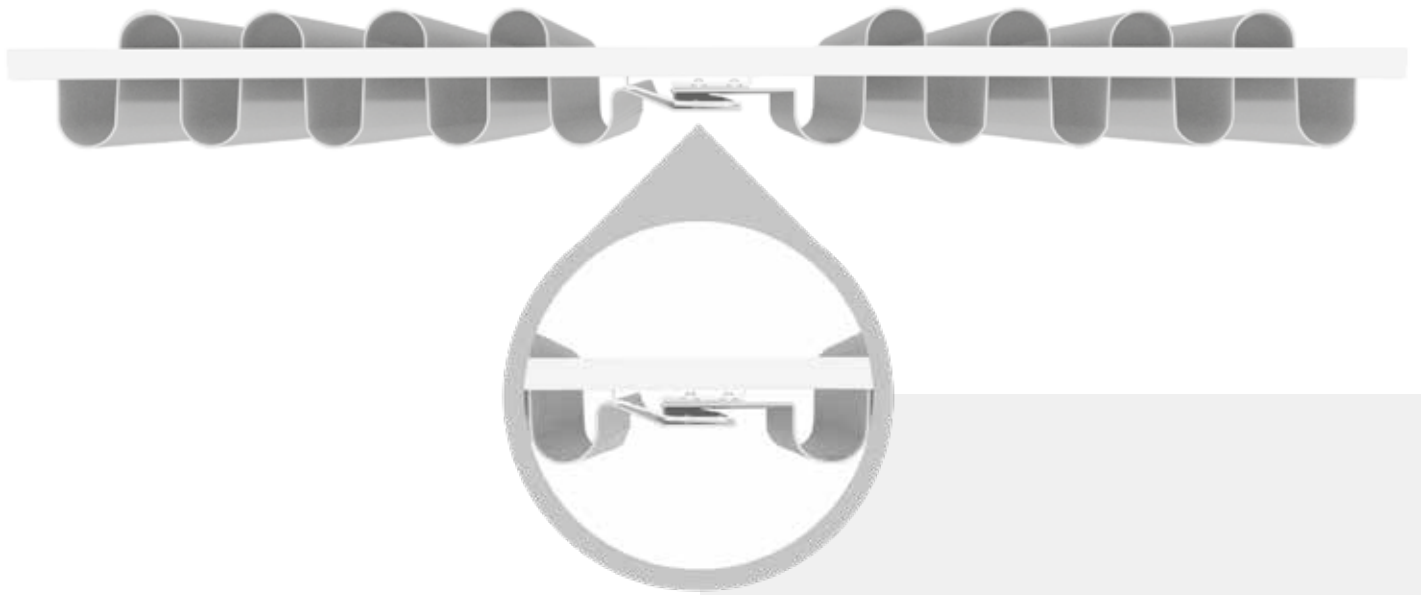

Sistema Light Off

Disminuye el paso de la luz gracias a un doblez interno en la confección de la cortina.

*Incluido en todas nuestras cortinas con telas black out.

Light Off System

Decreases the passage of light through an internal fold made in the drapes.

**Recommended for black out drapes.*

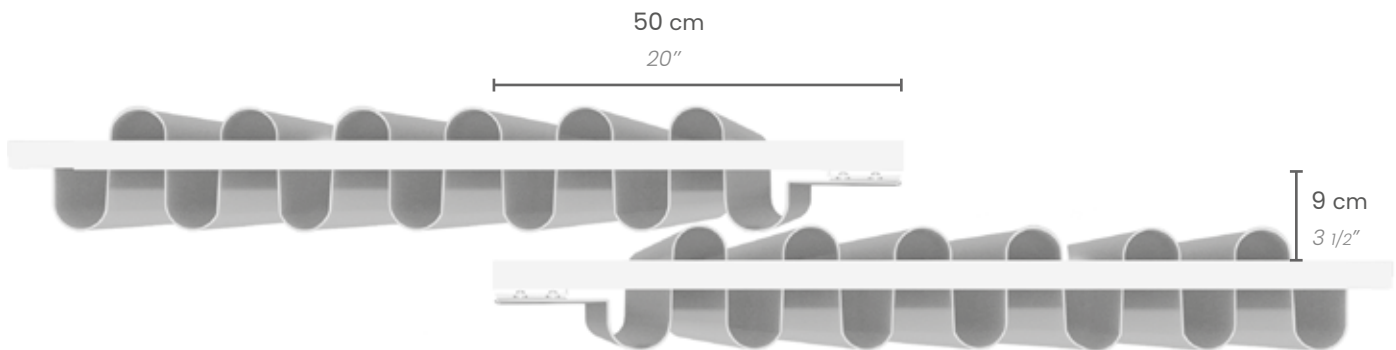

Sistema Never Light

Bloquea el paso de la luz mediante el traslape de 50 cm en su zona central.

Se recomienda en cortinero CS y cortinas black out.

Never Light System

Blocks the passage of light through a 20" overlap in its central area.

It is recommended for usage with CS heavy duty drape rod and black out drapes.

Cortineros

Draper Hardware

Contamos con cortineros en varios materiales y acabados que complementarán cualquier decoración y estilo en sus espacios.

We carry a large inventory of drapery hardware, enabling you to create styles that are sure to achieve your decorating and style goals.



Cláusula de envío para cortineros

1. Para envío con entrega a domicilio, los cortineros de medida superior a 4.5 mts, se enviarán seccionados en dos o más partes. No aplica en cortineros de madera, decorativo tubular y H-Riel en una hoja (dado que estos cortineros no se deben empalmar).

2. En cortineros de un solo tramo con medida superior a 4.5 mts, el envío de la mercancía se realizará ocurre al domicilio de la paquetería (debido a la limitación de esta para hacer entregas a domicilio en medidas de cortineros superiores a 4.5 mts). El cliente se responsabilizará por recoger la mercancía en la paquetería y transportar de manera adecuada los cortineros al lugar de la instalación.

Drape rod shipping policy

1. For home delivery, drape rods measuring more than 14.76 feet will be shipped sectioned in two or more parts. Does not apply to wooden, decorative tubular and H-Rail (on one panel) models (given these drape rod models should not be spliced).

2. In single-track rods with a length greater than 14.76 ft, the shipment of the tracks will be made as General Delivery (due to the limitation on home deliveries in measures of tracks greater than 14.76 feet). The customer will be responsible for collecting the merchandise and transporting it properly to the installation site.

Cortinero CS

CS Track System



Blanco
White

Negro
Black

Gris
Gray

Café
Brown

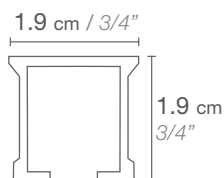

Apto para uso en hoteles por su resistencia
Recommended for use in hotels due to its resistance

Especificaciones técnicas

Technical specifications

Ancho máximo	6.1 m (1 hoja) 12.2 m (2 hojas)
Instalación	Muro o techo
Espacio de Instalación*	15 cm / 25 cm (2 cortineros)
Capacidad de carga	9 kg/ml
Bastón	90 cm, 120 cm, 150 cm

Max. width	20 ft (1 panel) 40 ft (2 panels)
Installation	Wall or ceiling
Installation space*	6" / 10" (2 tracks)
Weight capacity	6 lb/ lft
Baton	35 1/2", 47", 59"

Sugerencia de uso

- Plitz Francés
- Plitz Español
- Plitz Portugués

Suggested use

- French Pinch Pleat
- Spanish Pleat
- Portuguese Pleat

Soportes / Brackets



* Agregar 25 cm por hoja sistema Never Light

* Additional 10" per sheet for Never Light system

Cortinero con Cordón CCS

CCS Track System with cord



Especificaciones técnicas

Ancho máximo	6.1 m (1 hoja) 12.2 m (2 hojas)
Instalación	Muro o techo
Espacio de Instalación*	15 cm / 25 cm (2 cortineros)
Capacidad de carga*	5.95 kg/ml
Sugerencia de uso	<ul style="list-style-type: none"> • Plitz Francés • Plitz Español • Cortina Ondulada

Technical specifications

Max. width	20 ft (1 panel) 40 ft (2 panels)
Installation	Wall or ceiling
Installation space*	6" / 10" (2 tracks)
Weight capacity*	3.99 lb/ft
Suggested use	<ul style="list-style-type: none"> • French Pinch Pleat • Spanish Pleat • Ripplefold Drape

Soportes / Brackets



* Agregar 25 cm por hoja sistema Never Light

** No sobrepasar los 22 Kg de peso y los 3 m de altura, existe el riesgo de la caída del cortinero.

* Additional 10" per sheet for Never Light system

** Weight should not exceed 48.50 lb, and the length should be less than 9.84 ft, could be at risk of falling down.

Cortinero Sistema Ondulado

Ripplefold Track System

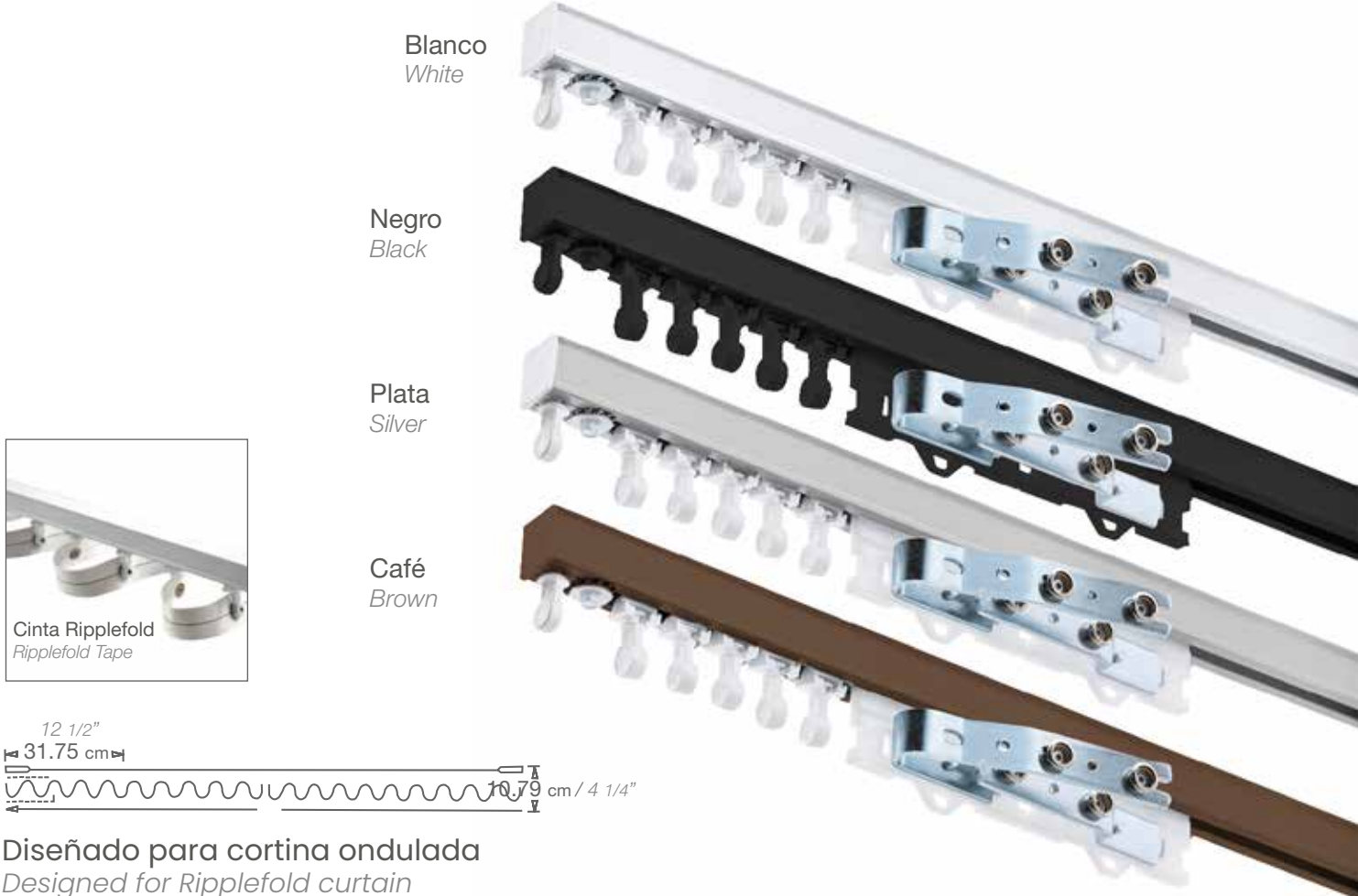

Diseñado para cortina ondulada
Designed for Ripplefold curtain

Especificaciones técnicas

Ancho máximo	6.1 m (1 hoja) 12.2 m (2 hojas)
Instalación	Muro o techo
Espacio de Instalación	15 cm / 25 cm (2 cortineros)
Capacidad de carga	9 kg/ml
Bastón	90 cm, 120 cm, 150 cm

Sugerencia de uso • Cortina Ondulada

Technical specifications

Max. width	20 ft (1 panel) 40 ft (2 panels)
Installation	Wall or ceiling
Installation space	5.90" / 9.84" (2 tracks)
Weight capacity	6 lb/ft
Baton	35 1/2", 47", 59"

Suggested use • Ripplefold Drape

Soportes / Brackets



Cortinero Curvo KS

KS Curved Track System



Cortinero curvo fabricado de aluminio

Curved track system made of aluminium

Especificaciones técnicas

Ancho máximo	7 m (1 hoja) 14 m (2 hojas)
Instalación	Muro o techo
Espacio de Instalación*	15 cm / 25 cm (2 cortineros)
Capacidad de carga	5.3 kg/ml
Bastón	90 cm, 120 cm, 150 cm
 Blanco	

- Sugerencia de uso
- Plitz Francés
 - Plitz Español
 - Cortina Ondulada

Technical specifications

Max. width	22.96 ft (1 panel) 45.93 ft (2 panels)
Installation	Wall or ceiling
Installation space*	6" / 10" (2 tracks)
Weight capacity	3.56 lb/ft
Baton	35 1/2", 47", 59"
 White	

- Suggested use
- French Pinch Pleat
 - Spanish Pleat
 - Ripplefold Drapes

Soportes / Brackets



* Agregar 25 cm por hoja sistema Never Light

* Additional 10" per sheet for Never Light system

Cortinero MTS

MTS Track System



Para ocultar en plafón
To hide in ceiling

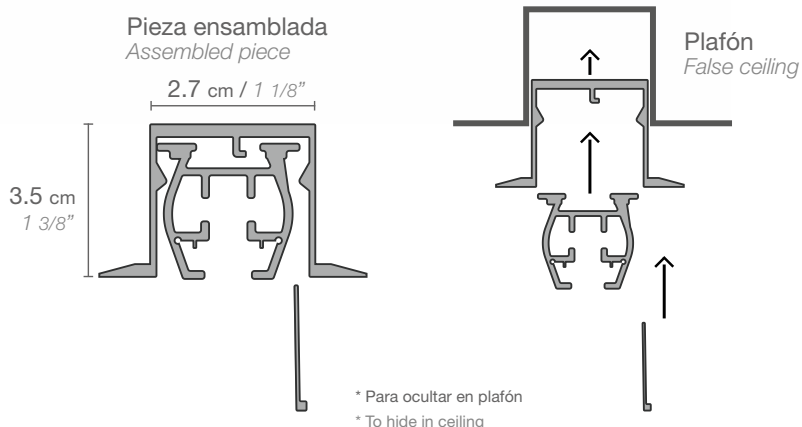

Cortinero diseñado para instalación oculta en plafón
Track system designed for concealed ceiling installation

Especificaciones técnicas

Ancho máximo	7 m (1 hoja) 14 m (2 hojas)
Instalación	A techo
Espacio de Instalación*	15 cm / 25 cm (2 cortineros)
Capacidad de carga	11.7 kg/ml
Bastón	90 cm, 120 cm, 150 cm
Blanco	

Sugerencia de uso

- Plitz Francés
- Plitz Español
- Cortina Ondulada

* Agregar 25 cm por hoja sistema Never Light

Technical specifications

Max. width	22.96 ft (1 panel) 45.93 ft (2 panels)
Installation	Ceiling
Installation space*	6" / 10" (2 tracks)
Weight capacity	7.86 lb/ft
Baton	35 1/2", 47", 59"
White	

Suggested use

- French Pinch Pleat
- Spanish Pleat
- Portuguese Pleat
- Ripplefold Drape

* Additional 10" per sheet for Never Light system

Cortinero DS XL

DS XL Track System

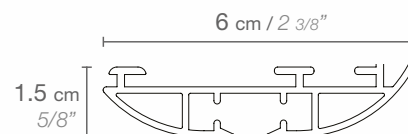

Sistema de cortinero doble vista

Double view track system

Especificaciones técnicas

Ancho máximo	6 m (1 hoja) 12 m (2 hojas)
Instalación	A techo
Espacio de Instalación	15 cm / 25 cm (2 cortineros)
Capacidad de carga	4.4 kg/ml
Bastón	90 cm, 120 cm, 150 cm

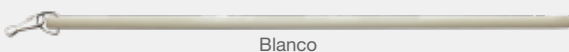

Blanco

Sugerencia de uso

- Plitz Francés
- Plitz Español
- Cortina Ondulada

Technical specifications

Max. width	19.68 ft (panels) 39.37 ft (2 panels)
Installation	Ceiling
Installation space	6" / 10" (2 tracks)
Weight capacity	2.97 lb/ft
Baton	35 1/2", 47", 59"



White

Suggested use

- French Pinch Pleat
- Spanish Pleat
- Ripplefold Drape

* Agregar 25 cm por hoja sistema Never Light

* Additional 10" per sheet for Never Light system

Cortinero decorativo "H" Riel

Decorative Metal "H" Track



Fabricado de aluminio
Made with aluminium

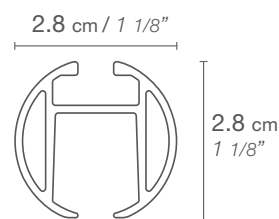

*No recomendable para cortinas black out
*Not recommended for black out drapes

Especificaciones técnicas

Ancho máximo	5.8 m (1 hoja) 11.6 m (2 hojas)
Instalación	Muro o techo
Espacio de Instalación	15 cm / 25 cm (2 cortineros)
Capacidad de carga	5.96 kg/ml
Bastón	90 cm, 120 cm, 150 cm
	Natural
	Café
	Negro

Sugerencia de uso

- Plitz Francés
- Plitz Español
- Plitz Portugués
- Cortina Ondulada

Technical specifications

Max. width	19 ft (1 panel) 38 ft (2 panels)
Installation	Wall or Ceiling
Installation space	6" / 10" (2 tracks)
Weight capacity	4 lb/ft
Baton	35 1/2", 47", 59"
	Natural
	Brown
	Black

Suggested use

- French Pinch Pleat
- Spanish Pleat
- Portuguese Pleat
- Ripplefold Drapes

Remates / Finials



*Remates y soportes disponibles en color café y negro satin
*Finials and brackets available in brown and satin black

Soportes / Brackets



Cortinero decorativo "E" Riel

Decorative Metal "E" Track



Fabricado de aluminio
Made with aluminium

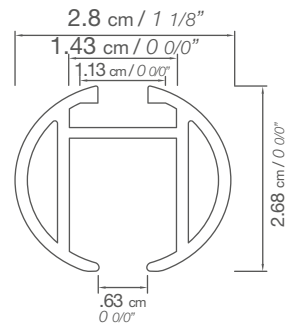

*No recomendable para cortinas black out
*Not recommended for black out drapes

Especificaciones técnicas

Ancho máximo	5.48 m (1 hoja) 10.98 m (2 hojas)
Instalación	Muro o techo
Espacio de Instalación	15 cm / 25 cm (2 cortineros)
Capacidad de carga	5.96 kg/ml
Bastón	90 cm, 120 cm, 150 cm
	Natural
	Negro

Sugerencia de uso

- Plitz Francés
- Plitz Español
- Plitz Portugués
- Cortina Ondulada

Technical specifications

Max. width	19 ft (1 panel) 38 ft (2 panels)
Installation	Wall or Ceiling
Installation space	6" / 10" (2 tracks)
Weight capacity	4 lb/lft
Baton	35 1/2", 47", 59"
	Natural
	Black

Suggested use

- French Pinch Pleat
- Spanish Pleat
- Portuguese Pleat
- Ripplefold Drape

Remates / Finials

Tapón / End cap



Bola / Ball



Soportes / Brackets

Sencillo / Simple

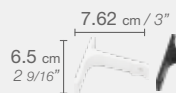

Doble / Double



De Techo / Ceiling



*Remates y soportes disponibles en color blanco y negro

*Finials and brackets available in white and black

Cortinero decorativo Tubular

Decorative Metal Track



Tubo de acero de 1"

1" Steel Rod



Color: Natural
Color: Natural



Color: Café oscuro
Color: Dark Brown



Color: Negro
Color: Black



Color: Bronce claro
Color: Light Bronze

Argolla 2"

2" Ring



Natural
Natural

Café oscuro
Dark brown

Negro
Black

Bronce claro
Light Bronze

*No recomendable para cortinas black out
*Not recommended for black out drapes

Especificaciones técnicas

Ancho máximo	2.5 m (1 hoja) 5 m (2 hojas)
Instalación	Muro o techo
Espacio de Instalación	15 cm / 25 cm (2 cortineros)
Capacidad de carga	4.4 kg/ml
Bastón	90 cm, 120 cm, 150 cm

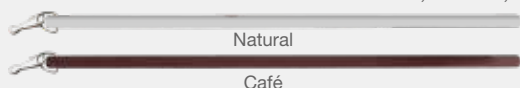

Natural

Café

Sugerencia de uso

- Plitz Francés
- Plitz Español
- Plitz Portugués
- Cortina Presillas
- Cortina Pasabarra
- Cortina Ojillo
- Cortina Visillo

Technical specifications

Max. width	8.2 ft (1 panel) 16.4 ft (2 panels)
Installation	Wall or Ceiling
Installation space	6" / 10" (2 tracks)
Weight capacity	2.95 lb/ft
Baton	35 1/2", 47", 59"

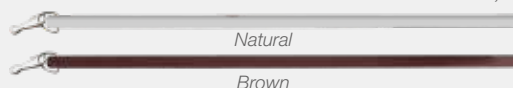

Natural

Brown

Suggested use

- French Pinch Pleat
- Spanish Pleat
- Portuguese Pleat
- Tab Top Drape
- Pocket Drape
- Grommet Drape
- Rod Pocket Drape

Remates / Finials

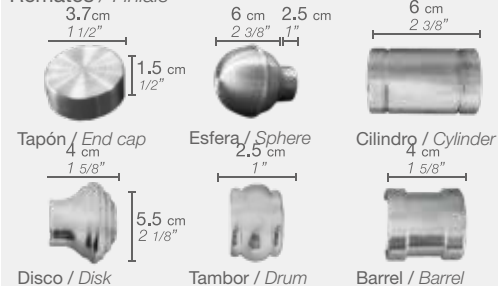

Tapón / End cap

Esfera / Sphere

Cilindro / Cylinder

Disco / Disk

Tambor / Drum

Barrel / Barrel

Soportes / Brackets

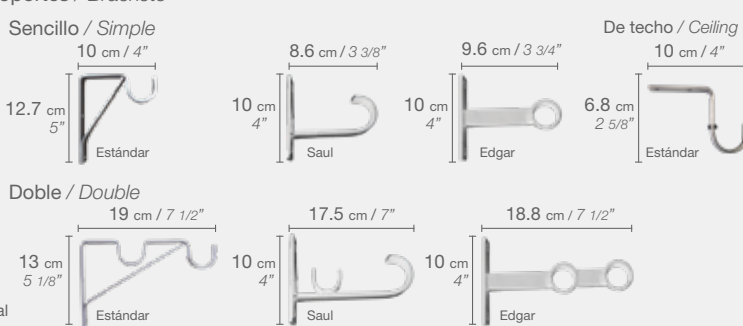

Sencillo / Simple

10 cm / 4"

12.7 cm / 5"

Estándar

Saul

Edgar

Doble / Double

19 cm / 7 1/2"

13 cm / 5 1/8"

Estándar

Saul

Edgar

De techo / Ceiling

10 cm / 4"

6.8 cm / 2 5/8"

Estándar

*Remates y soportes disponibles en color café, negro, bronce claro y natural
*Finials and brackets available in brown, black, light bronze and natural

Cortinero decorativo de Madera

Decorative Wooden Track

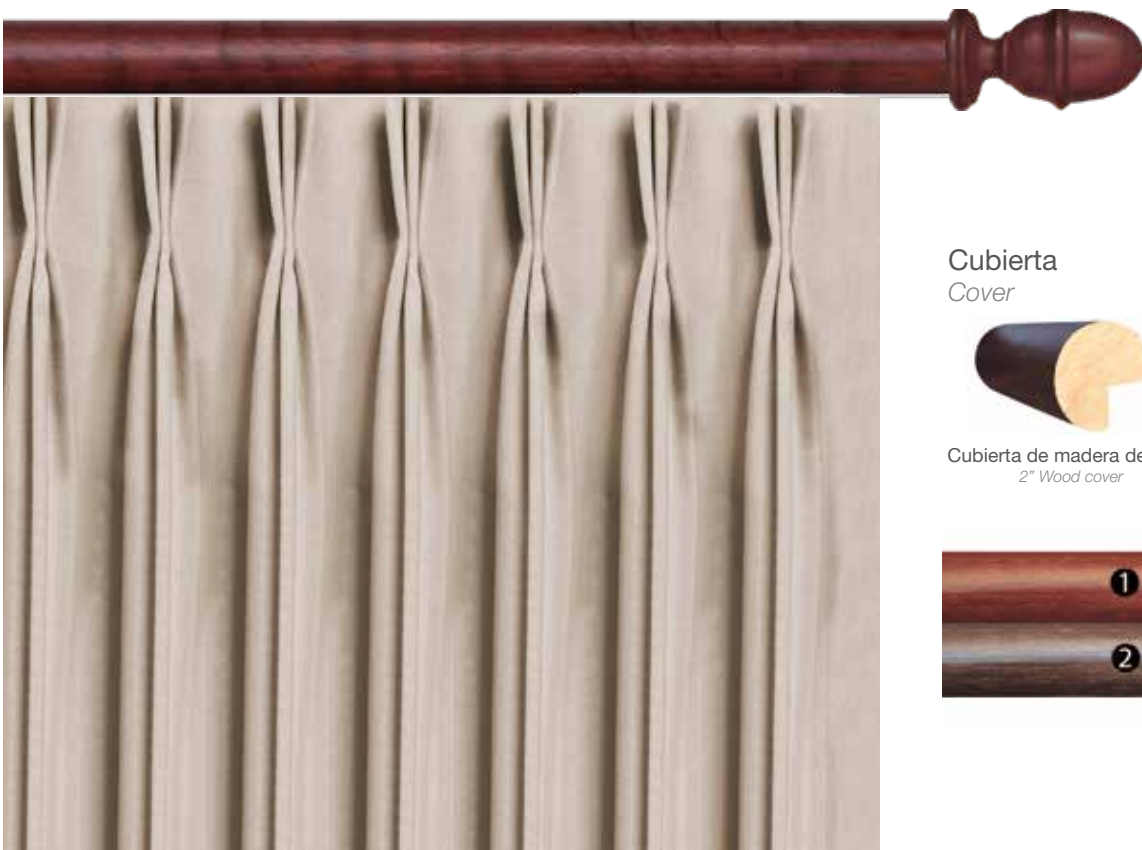

Cubierta

Cover



Cubierta de madera de 5 cm
2" Wood cover



Cubierta de madera de 5 cm
con CS
2" Wood cover with CS



Color: Hazel

Color: Walnut

Especificaciones técnicas

Ancho máximo	4.2 m (1 hoja ó 2 hojas)
Instalación	Techo / Muro
Espacio de Instalación	15 cm / 25 cm (2 cortineros)
Capacidad de carga	9 kg/ml
Bastón	90 cm, 120 cm, 150 cm

 Café oscuro

Sugerencia de uso

- Plitz Francés
- Cortina Ondulada
- Plitz Español
- Plitz Portugués

Remates / Finials



Technical specifications

Max. width	13.77 ft (1 or 2 panels)
Installation	Wall or Ceiling
Installation space	6" / 10" (2 tracks)
Weight capacity	6 lb/ft
Baton	35 1/2", 47", 59"

 Dark Brown

Suggested use

- French Pinch Pleat
- Ripplefold Drapes
- Spanish Pleat
- Ruffling Tape Drapes
- Portuguese Pleat
- Ruffling Pocket Drapes

Soportes / Brackets

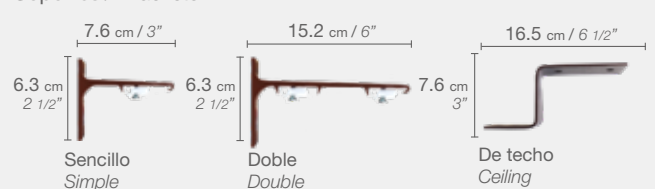

Cortinero Motorizado Glydea Ultra

Glydea Ultra Motorized System



Sofisticado sistema de motorización, con un diseño simple y elegante.
Sophisticated automated system with a simple and elegant design.

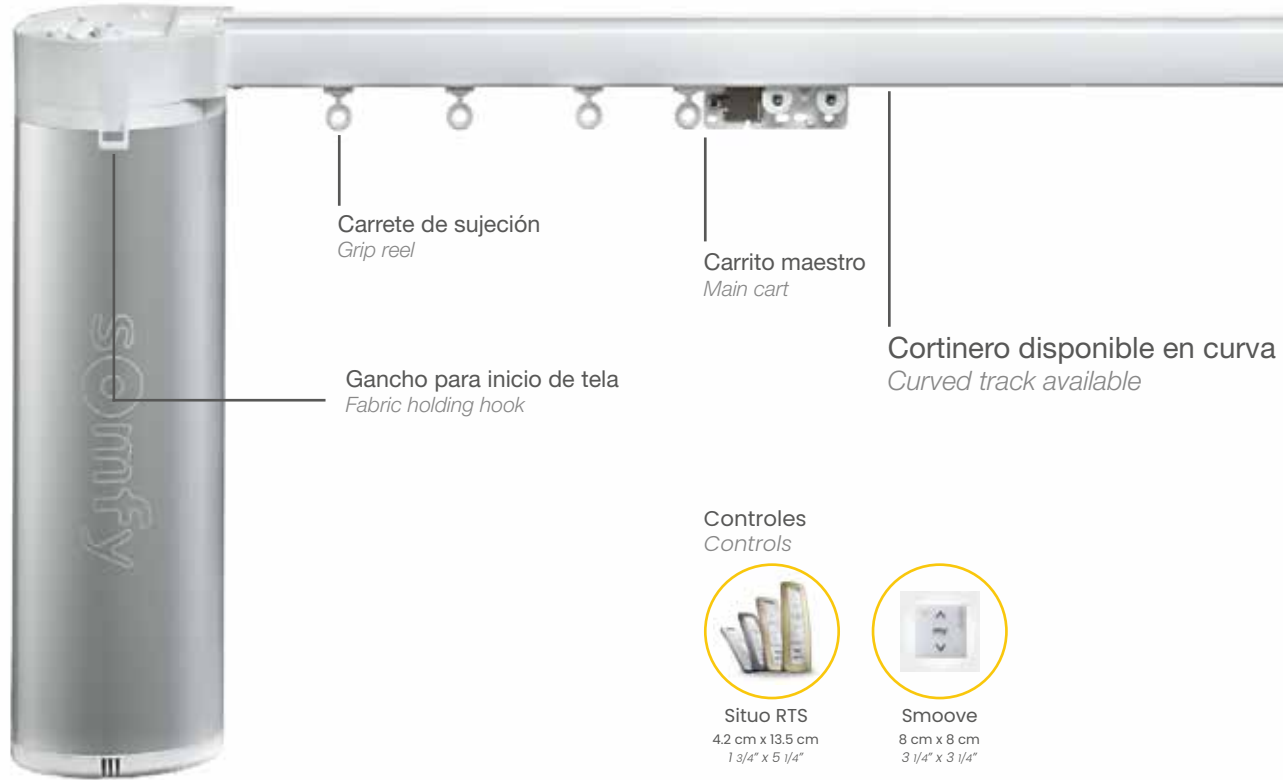

Especificaciones técnicas

Ancho máximo	15 m (1 motor) / 30 m (2 motores)
Instalación	Muro o techo
Espacio de Instalación*	15 cm / 25 cm (2 cortineros)
Capacidad de carga	35 kg (Glydea 35) / 60 kg (Glydea 60)
Información adicional	<ul style="list-style-type: none"> • Permite operación manual • Funcionamiento silencioso • Velocidad ajustable 12.5 cm, 17 cm y 20 cm/s • Radio mínimo de curva hasta 30 cm a 90° • "Tecnología Touch Motion" la cortina se abre con un ligero tirón
Sugerencia de uso	<ul style="list-style-type: none"> • Plitz Francés • Plitz Español • Cortina Ondulada

* Agregar 25 cm para sistema Never Light

Technical specifications

Max. width	49.21ft (1 motor) / 98.42 ft (2 motors)
Installation	Wall or ceiling
Installation space*	6" / 10" (2 motors)
Weight capacity	77.16 lb (Glydea 35) / 132.27 lb (Glydea 60)
Additional info	<ul style="list-style-type: none"> • Allows manual operation • Silent operation • Adjustable speed 5", 6 3/4" y 7 3/4"/s • Minimum curve ratio up to 11 3/4" at 90° • "Touch Motion Technology" the curtain moves with a slight pull
Suggested use	<ul style="list-style-type: none"> • French Pinch Pleat • Spanish Pleat • Ripplefold Drape

* Additional 10" for Never Light system



Soporte a muro
Wall support



Soporte a techo
Ceiling support



Cinta dentada reforzada
Reinforced ruffled tape

Diseño innovador

Innovative design

Sistema mecánico con tecnología “Lyrease” que desactiva automáticamente la transmisión del motor.

- Discreta posición de los botones y el cableado.
- Libre de mantenimiento después de la instalación.

Mechanical system with “Lyrease” technology that automatically deactivates the transmission of the engine.

- Discrete position of wiring and buttons.
- Does not require maintenance after installation.

Eficiente

Efficient

“Touch Motion” movimiento característico al toque del usuario, para abrir y cerrar las cortinas simplemente jalando la tela.

“my” función que al simple toque de un botón permite poner automáticamente la cortina a una posición preferida.

“Touch Motion” technology allows for movement of the curtain with just a light touch of the user, a simple pull on the fabric activates the system. “my” functionality allows programming of a preferred position with just the touch of a button.

Tandem

La alternativa Tandem es un sistema donde se utilizan dos motores, funciona cuando el peso de las cortinas excede la máxima capacidad de un sólo motor, logrando así hasta 100 kg.

The Tandem system uses two motors working together when the weight of the curtain exceeds the maximum capacity of a single engine, increasing the weight capacity to 220.46 lb.



Sistema Tandem
Tandem system

Cortinero Motorizado Movelite

Movelite Motorized System

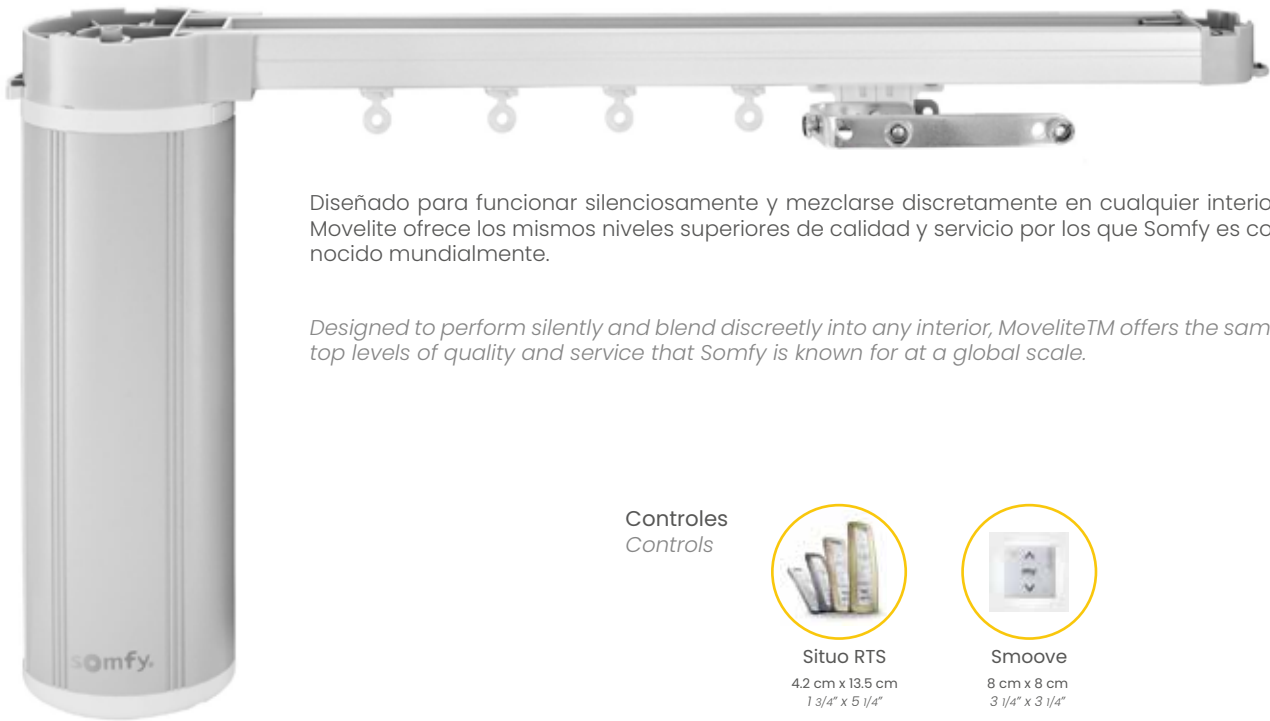

Diseñado para funcionar silenciosamente y mezclarse discretamente en cualquier interior, Movelite ofrece los mismos niveles superiores de calidad y servicio por los que Somfy es conocido mundialmente.

Designed to perform silently and blend discreetly into any interior, Movelite™ offers the same top levels of quality and service that Somfy is known for at a global scale.

Controles Controls



Situ RTS
4.2 cm x 13.5 cm
1 3/4" x 5 1/4"

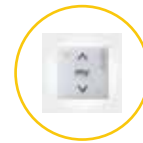

Smooove
8 cm x 8 cm
3 1/4" x 3 1/4"

Especificaciones técnicas

Ancho máximo	10 m (1 motor) / 20 m (2 motores)
Instalación	Muro o techo
Espacio de Instalación*	15 cm / 25 cm (2 cortineros)
Capacidad de carga	35 kg
Información adicional	<ul style="list-style-type: none"> • Permite operación manual • Velocidad 15 cm/s • Touch Motion
Sugerencia de uso	<ul style="list-style-type: none"> • Plitz Francés • Cortina Ondulada • Plitz Español

* Agregar 25 cm para sistema Never Light

Technical specifications

Max. width	32.80 ft (1 motor) / 65.61 ft (2 motors)
Installation	Wall or ceiling
Installation space*	6" / 10" (2 motors)
Weight capacity	77.16 lb
Additional info	<ul style="list-style-type: none"> • Allows manual operation • Up to 9 month battery life • Opening speed 6"/s • Touch Motion
Suggested use	<ul style="list-style-type: none"> • French Pinch Pleat • Ripplefold Drape • Spanish Pleat

* Additional 10" for Never Light system

Ventajas

Confort y Conveniencia

- Excelente para eliminar reflejos o crear privacidad instantánea
- Abra o cierre cortinas con tan solo presionar un botón
- Control desde prácticamente cualquier lugar utilizando la aplicación móvil

Ahorros de Energía

- Reduce el consumo de energía hasta en un 40%
- Proteja muebles valiosos de los dañinos rayos UV
- Agregue sensores o temporizadores opcionales para el control automático

Benefits

Comfort and Convenience

- Great for reducing glare or creating instant privacy
- Open or close draperies as easily as pressing a button
- Control from virtually anywhere using the mobile app
- Rechargeable battery

Energy Savings

- Reduce energy consumption by up to 40%
- Protect valuable furnishings from harmful UV rays
- Add optional sensors or timers for automatic control

Cortinero Motorizado Irismo WireFree

Irismo WireFree Motorized System



Sistema de motorización completamente libre de cables.
Automated system completely free of cables.

Especificaciones técnicas

Ancho máximo	10 m (1 motor) / 20 m (2 motores)
Instalación	Muro o techo
Espacio de Instalación*	15 cm / 25 cm (2 cortineros)
Capacidad de carga	45 kg
Información adicional	<ul style="list-style-type: none"> • Permite operación manual • Batería con duración de hasta 9 meses • Velocidad 12.5cm/s • Touch Motion
Sugerencia de uso	<ul style="list-style-type: none"> • Plitz Francés • Cortina Ondulada • Plitz Español

* Agregar 25 cm para sistema Never Light

Technical specifications

Max. width	32.80 ft (1 motor) / 65.61 ft (2 motors)
Installation	Wall or ceiling
Installation space*	6" / 10" (2 motors)
Weight capacity	99.20 lb
Additional info	<ul style="list-style-type: none"> • Allows manual operation • Up to 9 month battery life • Opening speed 5"/s • Touch Motion
Suggested use	<ul style="list-style-type: none"> • French Pinch Pleat • Spanish Pleat • Ripplefold Drape

* Additional 10" for Never Light system



Ventajas

Límites Automáticos

Establecimiento y reajuste automático de límites, cambio de sentido de giro y velocidad ajustable.

Batería

Batería recargable con duración de hasta 9 meses. El adaptador de voltaje para recargar la batería se vende por separado.

Advantages

Automatic limits

Limit delimitation and readjustment, chance of rotations and adjustable speed.

Battery

Up to 9 months of battery life. Adapter for battery recharging sold separately.

Controles

Controls



Situo RTS
4.2 cm x 13.5 cm
1 3/4" x 5 1/4"



Smoove
8 cm x 8 cm
3 1/4" x 3 1/4"



Situo RTS

Control remoto disponible en 1,2 y 5 canales con botón programable para posición predilecta.
Control device used for activating RTL automated technology systems (1,2 and 5 channels).

Tipo de control / Control type	Portátil	Portable
Dimensiones / Dimentions	4.2 cm x 13.5 cm	1 3/4" x 5 1/4"
Alimentación / Power supply	Batería de 3V	3V Battery
Temp. de operación / Operation temp.	-20°C a 60°C	-4°F to 140°F
Alcance / Range	20 m atravesando 2 muros	65.61 ft through 2 walls



Smooove Blanco / Negro

Interruptor táctil inalámbrico para fijación a pared (1, 2 y 4 canales).
Wireless wall mounted touch control (1,2 and 4 channels).

Tipo de control / Control type	Fijo / Inalámbrico	Fixed / Portable
Dimensiones / Dimentions	8 cm x 8 cm	3 1/4" x 3 1/4"
Alimentación / Power supply	Batería de 3V	3V Battery
Temp. de operación / Operation temp.	0°C a 60°C	32°F to 140°F
Alcance / Range	20 m atravesando 2 muros	65.61 ft through 2 walls

Sistemas inteligentes

Intelligent Systems



La solución completa a la automatización del hogar, la centralización y control de todos sus dispositivos dentro de un sistema práctico y personalizable de fácil uso.

The complete solution to home automation, the centralization and control of all your devices within a practical, easy-to-use and customizable system.

Beneficios de la Automatización

- Ahorro en el consumo energético al reducir el uso de aire acondicionado y/o calefacción.
- Confort visual en todo momento al beneficiarse de la mayor cantidad de luz natural posible mientras se evitan los brillos y reflejos.
- Un retorno de inversión, como resultado del ahorro y la reducción de los costos de mantenimiento.

Benefits of automatization

- High energy efficiency reduces the need for air conditioning and heating systems.
- Visual comfort at all times by benefiting from as much natural light as possible while avoiding glare and reflections.
- A return on your investment, as a result of saving and reducing maintenance costs.

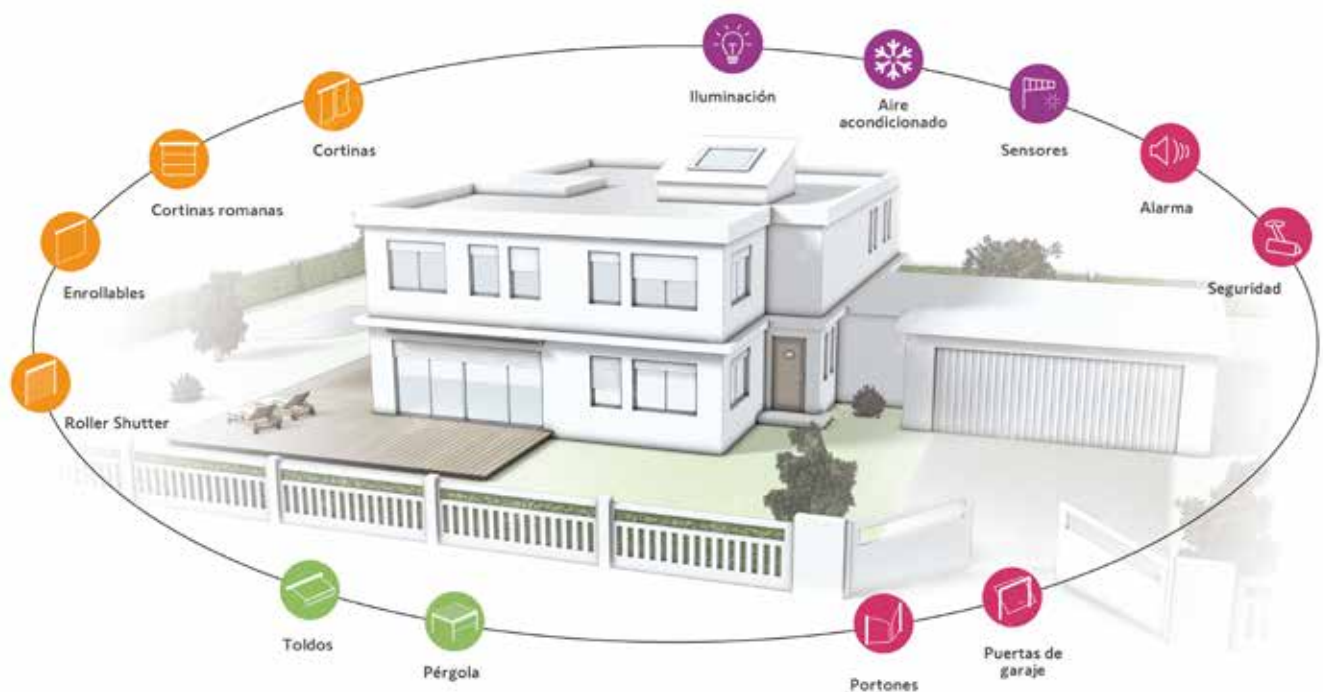

Domótica

Home Automation



Inteo Station V2

Sistema domótico para el control de cortinas, persianas, toldos, luces y monitoreo de accesos.

Automated system for the control of curtains, blinds, awnings, lights and access monitoring.

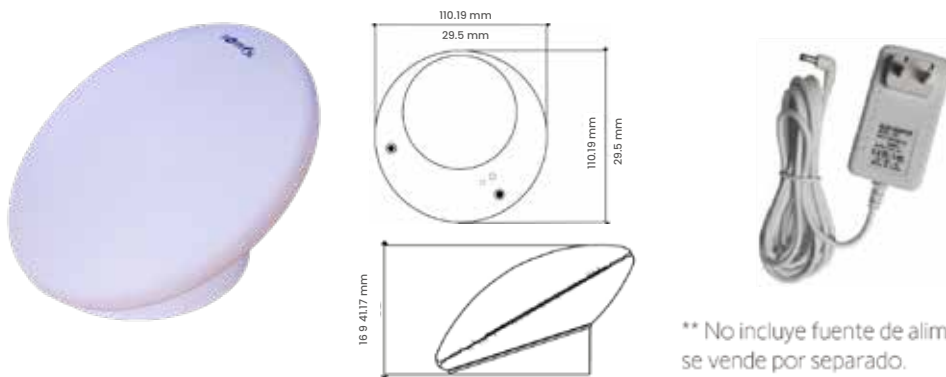

** No incluye fuente de alimentación, se vende por separado.

Compatibilidad

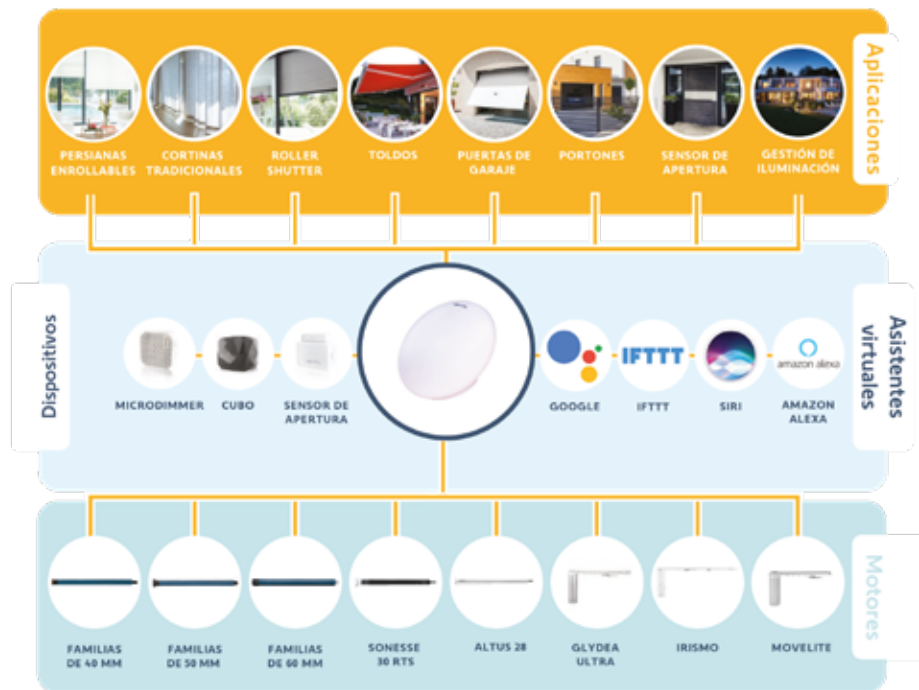

Por medio de la aplicación móvil de Somfy, los usuarios pueden enviar comandos inmediatos, crear escenarios (hacer que un grupo de productos funcionen al mismo tiempo) y eventos (temporizados).

Los usuarios podrán tener control desde cualquier lugar con acceso a internet gracias a la función remota.

Through the application mobile of Somfy, users can send immediate commands, create scenarios (make a group of products work at the same time) and events (timed).

Users can have control from anywhere with access to the internet thanks to the remote function.

Microdimmer

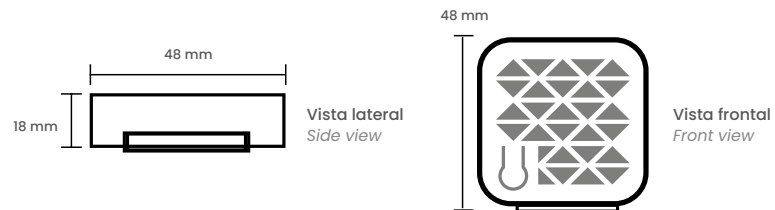

Dispositivo equipado con un microcontrolador que permite regular la intensidad de cargas de iluminación.

Device equipped with a microcontroller that allows to regulate the intensity of lighting loads.

Sensor de apertura

Opening sensor

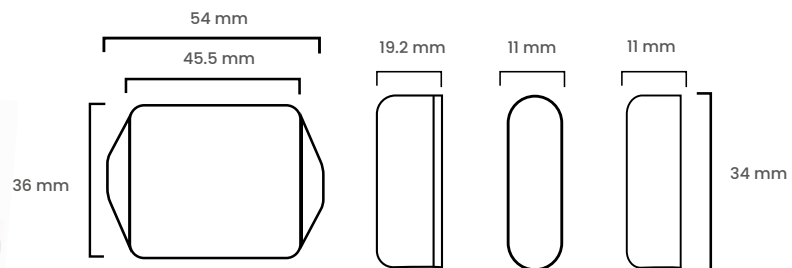

Dispositivo electrónico que monitorea la apertura o cierre de puertas y/o ventanas.

Electronic device that monitors the opening or closing of doors and / or windows.

A photograph of a modern hotel room. In the foreground, a bed with white linens and a patterned pillow is visible. A wicker bench sits on the floor. In the background, there is a seating area with colorful pillows and a view of the ocean through a large window. A wicker lamp hangs from the ceiling.

Decorativos *Decorative Products*

Secrets Maroma, Riviera Cancún

Fabricamos productos decorativos de alto rendimiento para cualquier habitación.

Nuestra variedad de modelos y estilos es amplia y se adapta a las necesidades y medidas específicas de cada cliente.

We manufacture high performance decorative products for any type of room.

Our wide variety of models and styles adapts to the needs and specific measurements of each client.



Cubrecamas *Bed covers*

Proyecto Camino Al Mar, Mazatlán, Sinaloa.

Accesorio decorativo que se coloca sobre la cama. Unifica el cromatismo de la habitación combinándose con el estilo de las cortinas, cojines decorativos y tapicería.

It is a decorative product placed on top of the bed. They are the unifying element responsible for the colours of the room combined with the style of curtains, decorative pillows and upholstery.

Funda de duvet

Duvet covers

Es una funda decorativa y complemento para el inserto de duvet que se utiliza como cubrecama. Su confección puede ser con cierre o tipo sobre.

It is a decorative cover and complement to the duvet insert that is used as a bedspread. It can be made with a zipper or an envelope closure (innerflap).



Tamaño	Medidas
Individual	173 cm x 243 cm
Matrimonial	208 cm x 243 cm
Queen	223 cm x 243 cm
King	273 cm x 243 cm

**Las medidas pueden ajustarse a las necesidades del cliente.*

Size	Dimensions
Twin	68" x 96"
Full	82" x 96"
Queen	89" x 96"
King	107" x 96"

**Dimensions can be adjusted to the client's requirements.*

Esquemas funda de duvet

Duvet cover diagram

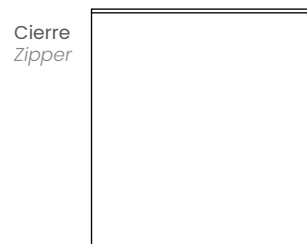
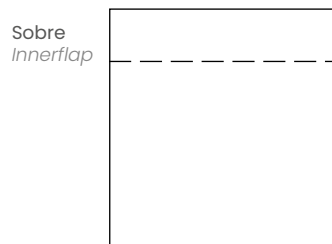

Colcha al caer

Bedsread

Estandar

Es una colcha cuya altura cubre hasta el colchón, cubre las almohadas y requiere rodapié.

Grande

Es una colcha cuya caída cubre parte del box, cubre almohadas y requiere rodapié.

Extra Grande

Es una colcha que tiene caída hasta el piso y cubre las almohadas. Confeccionada con una tela decorativa que no requiere capitonarse.

Standard

A bedcover that goes down to the mattress, covers the pillows and requires a bedskirt.

Large

It is a quilt whose fall covers part of the box, covers pillows and requires a skirting board.

Extra Large

A bedcover with sides that goes down to the floor. It does not require a bed skirt, it goes over the pillows and it is not quilted..



Tamaño	Medidas			Size	Dimensions		
	Estandar	Grande	Extra Grande**		Standard	Large	Extra Large**
Individual	170 cm x 274 cm	190 cm x 274 cm	210 cm x 290 cm	Individual	67" x 108"	74" x 108"	83" x 114"
Matrimonial	205 cm x 274 cm	225 cm x 274 cm	245 cm x 290 cm	Matrimonial	81" x 108"	88" x 108"	96" x 114"
Queen	220 cm x 274 cm	240 cm x 274 cm	260 cm x 290 cm	Queen	87" x 108"	94" x 108"	102" x 114"
King	270 cm x 274 cm	290 cm x 274 cm	310 cm x 290 cm	King	106" x 108"	114" x 108"	122" x 114"

*Las medidas pueden ajustarse a las necesidades del cliente.

**Se requiere tela 3.00 ancho

*Dimensions can be adjusted to the client's requirements.

**118" inches fabric required

Colchas Disponibles

Quilts Available

Colcha al caer Areg

Diseño de rombos

Bedsread Areg
with diamond design

82% poliéster
18% algodón

82% polyester
18% cotton



Doe

Colcha al caer Draji

Diseño de líneas

Bedsread Draji
with striped design

82% poliéster
18% algodón

82% polyester
18% cotton



Crudo
Ecrú

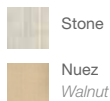

Colcha al caer Kipp

Diseño de rombos

Bedsread Kipp
with diamond design

66% poliéster
34% algodón

66% polyester
34% cotton

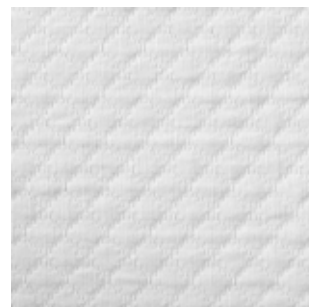

Blanco
White

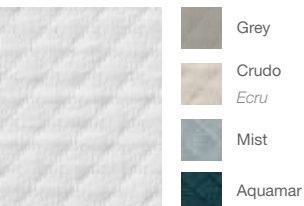

*Aplica para colcha extra grande.
*Applies to extra large quilt.

Colcha al caer Palmar

Diseño hoja de palma

Bedsread Palmar
with palm leaves design

55% poliéster
45% algodón

55% polyester
45% cotton

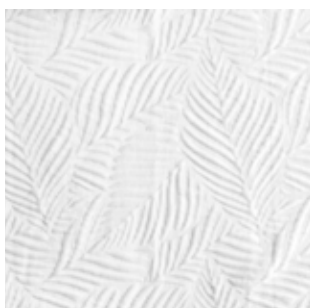

Blanco
White

Colcha al caer Polka

Diseño de puntos

Bedsread Polka
with a dots design

55% poliéster
45% algodón

55% polyester
45% cotton



Blanco
White

Colcha al caer Memphis

Diseño de ondas

Bedsread Memphis
with waves design

55% poliéster
45% algodón

55% polyester
45% cotton



Blanco
White



Cobertores Blankets



Confeccionados con tela suave y cálida.

Made of soft fabric, used especially for warmth.

Tamaño	Medidas	
	Escania	Alpes
Individual	160 cm x 210 cm	160 cm x 250 cm
Matrimonial	180 cm x 210 cm	180 cm x 250 cm
Queen	210 cm x 210 cm	210 cm x 250 cm
King	250 cm x 210 cm	250 cm x 250 cm

*Las medidas pueden ajustarse a las necesidades del cliente.

Size	Dimensions	
	Escania	Alpes
Twin	62" x 83"	62" x 98"
Full	70" x 83"	70" x 98"
Queen	83" x 83"	83" x 98"
King	98" x 83"	98" x 98"

*Dimensions can be adjusted to the client's requirements.

Cobertor Alpes

Alpes blanket

Brinde un toque de comodidad a sus habitaciones con nuestros cobertores Alpes, confeccionados con tejidos 100% poliéster de textura afelpada.

Give a touch of comfort to your rooms with our Alpes blankets, made with 100% polyester fabrics with plush texture.



Colores disponibles:

Available colors:



Cobertor Escania

Escania blanket



Frazadas Throws

Mahekal Beach Resort, Riviera Cancún

Accesorio decorativo que se coloca al pie de la cama.

An accesory that goes at the end of the bed and it is used as decoration.

Tamaño	Medidas	
	Con marco	Coverlet
Individual	170 cm x 65 cm	170 cm x 130 cm
Matrimonial	205 cm x 65 cm	205 cm x 130 cm
Queen	220 cm x 65 cm	220 cm x 130 cm
King	270 cm x 65 cm	270 cm x 130 cm

*Las medidas pueden ajustarse a las necesidades del cliente.

Size	Dimensions	
	With border	Coverlet
Twin	67" x 25"	67" x 51"
Full	81" x 25"	81" x 51"
Queen	87" x 25"	87" x 51"
King	106" x 25"	106" x 51"

*Dimensions can be adjusted to the client's requirements.



Frazada sencilla o doble vista
Simple throw

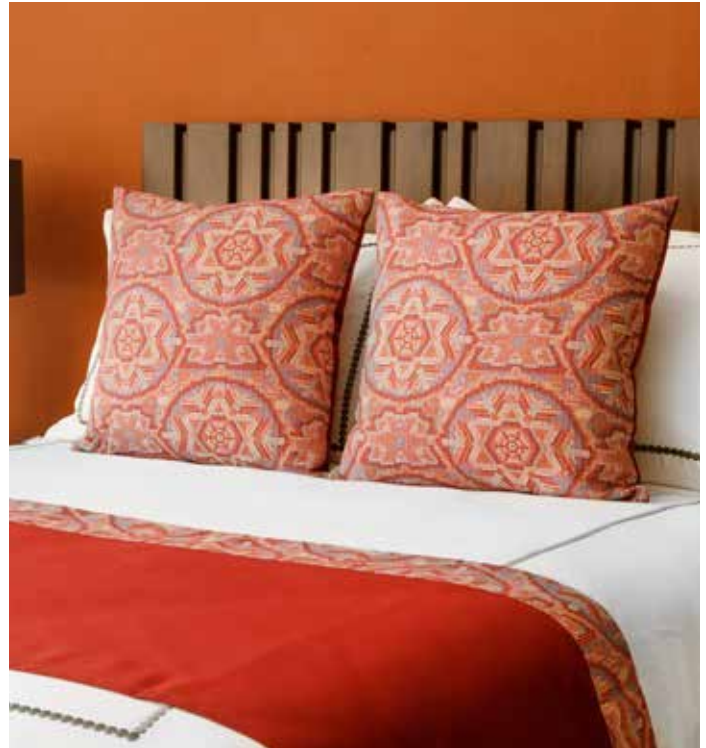

Frazada con cenefa
Kilter throw



Frazada con marco
Throw with border



Frazada coverlet
Coverlet throw

Rodapiés & Cubrebox

Bed skirts & Box covers



Piezas decorativas que se utilizan para cubrir la base de la cama. Se colocan entre la base de la cama y el colchón.

Decorative pieces used to cover the boxspring or bed base. They fit between the mattress and boxspring and hang to the floor.

Medidas

Tamaño	Con marco
Individual	100 cm x 200 cm x 35 cm
Matrimonial	135 cm x 200 cm x 35 cm
Queen	150 cm x 200 cm x 35 cm
King	200 cm x 200 cm x 35 cm

*Las medidas pueden ajustarse a las necesidades del cliente.

Dimensions

Size	With border
Twin	37" x 79" x 14"
Full	53" x 79" x 14"
Queen	59" x 79" x 14"
King	79" x 79" x 14"

*Dimensions can be adjusted to the client's requirements.



Cojines decorativos

Decorative pillows

Accesorio decorativo relleno de fibra de poliéster con forro y funda de tela decorativa.
Decorative soft bag filled with polyester staple fiber and a decorative cover.

Medidas

60 cm x 20 cm	Cilindro
60 cm x 30 cm	Rectangular
45 cm x 45 cm	Cuadrado
50 cm x 50 cm	
55 cm x 55 cm	
60 cm x 60 cm	

*Las medidas pueden ajustarse a las necesidades del cliente.

Dimensions

24" x 12"	Bolster
24" x 7"	Rectangular
18" x 18"	Squared
20" x 20"	
22" x 22"	
24" x 24"	

*Dimensions can be adjusted to the client's requirements.



Cojín decorativo estándar
Standard decorative pillow



Cojín decorativo con vivo
Welted decorative pillow



Cojín decorativo con marco de 3 cm
Decorative pillow with 1" flange



Cojín decorativo bitono
Duo-toned decorative pillow



Cojín decorativo rectangular con vivo
Welted rectangular decorative pillow



Cojín cilindro (con o sin vivo)
Duotoned decorative pillow (available with welt)



Cojín decorativo rectangular bitono
Duo-toned rectangular decorative pillow



Cojín decorativo tricolor
Tri-colored decorative pillow

Almohadones decorativos

Decorative shams



Cojín rectangular decorativo relleno de fibra de poliéster con forro y funda de tela decorativa que complementa la decoración de la cama.

It is a decorative soft bag filled with polyester staple fiber with a cover and a decorative fabric as a pillow sham.

Tamaño	Medidas
Matrimonial	65 cm x 50 cm
Queen Size	71 cm x 50 cm
King Size	90 cm x 50 cm

*Las medidas pueden ajustarse a las necesidades del cliente.

*Marco adicional de 3 cm no incluido en las medidas.

Size	Dimensions
Full	26" x 20"
Queen Size	28" x 20"
King Size	35" x 19"

*Dimensions can be adjusted to the client's requirements.

*1" Frame not included in Dimensions.



Almohadón decorativo estándar
Standard decorative pillow sham



Almohadón decorativo bitono
Duo-toned decorative pillow sham



Almohadón decorativo con marco de 3cm
Decorative pillow sham with 1.1" flange



Almohadón decorativo con vivo
Welted decorative pillow sham

Ropa de Cama

Bed Linen

Tejidos en stock | *Fabrics in stock*

Información técnica | *Technical specs*

DISEÑO <i>DESIGN</i>	COLOR	TEJIDO <i>WEAVE</i>	HILOS <i>THREAD COUNT</i>	COMPOSICIÓN <i>COMPOSITION</i>	ANCHO <i>WIDTH</i>	PESO <i>WEIGHT</i>	INST. DE LAVADO <i>CARE INSTRUCTIONS</i>
Alba		Percal	200	100% COT	2.8 m	110 gr/m ²	
Plat		Sateen	300	100% COT	3.0 m	110 gr/m ²	
Giza		Sateen	400	100% COT	3.0 m	128 gr/m ²	
Arcus	Blanco <i>Óptico</i>	Percal	180	50% COT - 50% PES	2.8 m	112.5 gr/m ²	
Vila Plus		Percal	200	50% COT - 50% PES	2.8 m	118.5 gr/m ²	
Faiza	Optical <i>White</i>	Sateen	250	60% COT - 40% PES	3.0 m	143 gr/m ²	
Clio		Sateen Stripe	250	50% COT - 50% PES	2.8 m	140 gr/m ²	
Alina		Sateen	300	80% COT - 20% PES	3.0 m	135 gr/m ²	
Adiva		Microfibra	--	100% PES	2.8 m	100 gr/m ²	

*COT: Algodón - Cotton *PES Poliéster - Polyester

Sábanas

Bed sheets

Nuestras sábanas de mezcla de algodón enriquecido 60% algodón 40% poliéster o 100% algodón ofrece un tacto y calidad superior para sus huéspedes.

Our enriched 60% cotton - 40% polyester mix or 100% cotton offers a softer touch and a higher quality for your guests.



Medidas (cm)

Tamaño	Sábana Plana			Sábana de Cajón		Fundas de Almohada	Fundas de Almohadón
	Estándar	Grande	Extra Grande**	Estándar	Grande		Con marco
Individual	200 x 265	200 x 270	200 x 286	100 x 200 x 35	100 x 200 x 45	100 x 52	96 x 56
Matrimonial	235 x 265	235 x 270	235 x 286	135 x 200 x 35	135 x 200 x 45	76 x 52	71 x 56
Queen	250 x 265	250 x 270	250 x 286	150 x 200 x 35	150 x 200 x 45	86 x 52	77 x 56
King	300 x 265	300 x 270	300 x 286	200 x 200 x 35	200 x 200 x 45	100 x 52	96 x 56

*Las medidas pueden ajustarse a las necesidades del cliente.

**Extra grande solo con telas de 3.00 m

Dimensions (in)

Size	Flat sheet			Fitted sheet		Pillow case	Pillow sham
	Standard	Large	Extra Large**	Standard	Large		With flange
Twin	79 x 104	79 x 106	79 x 113	39 x 79 x 14	39 x 79 x 18	39 x 20	38 x 22
Full	93 x 104	93 x 106	93 x 113	53 x 79 x 14	53 x 79 x 18	30 x 20	12 x 22
Queen	98 x 104	98 x 106	98 x 113	59 x 79 x 14	59 x 79 x 18	34 x 20	30 x 22
King	118 x 104	118 x 106	118 x 113	79 x 79 x 14	79 x 79 x 18	39 x 20	38 x 22

*Dimensions can be adjusted to the client's requirements.

**Extra large only with 118" Inches fabrics

Almohadas

Sleeping Pillows

Nuestras almohadas satisfacen las diferentes necesidades del mercado en presentaciones firme, media, suave y extra suave.

Utilizamos fibras especialmente desarrolladas para almohadas que brindan mayor resistencia y soporte, ayudando al mismo tiempo a mejorar la circulación del aire, creando un microclima agradable durante todo el día y la noche.

Las fibras sintéticas tienen un efecto parecido a las fibras naturales (como las plumas o el plumón), con la ventaja de que son de fácil mantenimiento.

Our pillows meet the different needs of the market in firm, medium, soft and extra soft presentations.

We use specially developed fibers for pillows that provide greater strength and support, while helping to improve air circulation, creating a pleasant microclimate throughout the day and night.

Synthetic fibers have a similar effects than natural fibers (such as feathers or down), with the advantage that they are easy to care for.

Sistema de llenado

Filling system

Nuestra línea de producción se conforma de cuatro dispositivos de marca europea líder en la fabricación de equipos para el procesamiento de fibras.

La tecnología de llenado es por succión que garantiza calidad, homogeneidad y versatilidad del llenado de distintos tipos y tamaños de fundas; ya sea para almohadas o cojines.

Our processing line is made up of four machines from a European leading company in fiber processing equipment.

The filling vacuum suction technology guarantees quality, homogeneity and versatility when filling different types and sizes of pillows.



Modelo	Tamaños (cm)		Fibra	Tela	Nivel de Firmeza	Peso
Classic Nadur	Estándar	66 x 51	Microgel 100% Poliéster	230 Hilos 100% Algodón Downproof	Firme	675 gr
	Queen	73 x 51				750 gr
	King	91 x 51				964 gr
Terapéutica	Estándar	61 x 45 x 5	Down Alternative Fibra Corta Conjugada	230 Hilos 100% Algodón Downproof	Medio	1080 gr
	Queen	68 x 45 x 5				1290 gr
	King	86 x 45 x 5				1520 gr
Luxury Max	Estándar	66 x 51	Down Alternative Fibra siliconizada 100% Poliéster	230 Hilos 100% Algodón Downproof	Suave	780 gr
	Queen	73 x 51				890 gr
	King	91 x 51				1070 gr
Deluxe Premium	Estándar	66 x 51	Down Alternative 100% Poliéster	230 Hilos 100% Algodón Downproof	Extra Suave	920 gr
	Queen	73 x 51				1125 gr
	King	91 x 51				1460 gr

Model	Size (in)		Fill	Fabric	Firmness Level	Weight
Classic Nadur	Standard	26 x 20	Microgel 100% Polyester	230 TC 100% Cotton Downproof	Firm	23 oz
	Queen	29 x 20				26 oz
	King	36 x 20				34 oz
Therapeutic	Standard	24 x 18 x 2	Down Alternative Short Conjugated Fiber	230 TC 100% Cotton Downproof	Medium	38 oz
	Queen	26 x 18 x 2				45 oz
	King	34 x 18 x 2				53 oz
Luxury Max	Standard	26 x 20	Down Alternative Siliconized fiber 100% Polyester	230 TC 100% Cotton Downproof	Soft	28 oz
	Queen	29 x 20				32 oz
	King	36 x 20				38 oz
Deluxe Premium	Standard	26 x 20	Down Alternative 100% Polyester	230 TC 100% Cotton Downproof	Extra Soft	33 oz
	Queen	29 x 20				40 oz
	King	36 x 20				52 oz



Protectores de almohada

Pillow protectors



Protector de almohada con cordones
Pillow protector with laces



Protector de almohada impermeable con cierre
Waterproof pillow protector with zipper

Tamaño		Tela	
Protector de almohada con cordón o cierre	Matrimonial	69 cm x 51 cm	Arcus 180 Hilos 50% Alg. - 50% Pol.
	Queen	79 cm x 51 cm	Microfibra 100 gr - 100% Pol.
	King	94 cm x 51 cm	Econfort 100% Pol. Backing 100% Pu.
Protector de almohada impermeable con cierre			Tecnocool 75% Cooling 25% Pol.

*PU: Poliuretano

Size		Fabric	
Pillow protector with laces or zipper	Full	27" x 20"	Arcus 180 TC 50% Cot. - 50% Pol.
	Queen	31" x 20"	Microfiber 100 gr - 100% Pol.
	King	37" x 20"	Econfort 100% Pol. Backing 100% Pu.
Waterproof pillow protector with zipper			Tecnocool 75% Cooling 25% Pol.

*PU: Polyurethane

Insertos de Duvet

Duvet inserts

Utilizando fibras sintéticas y tela en mezcla de algodón con poliéster se logra un inserto de duvet hipoalergénico de la más alta calidad.

Son más ligeros que los de fibras naturales y más prácticos ya que son de fácil mantenimiento.

The use of synthetic fibers and the combination of cotton with polyester fabric achieves a hypoallergenic duvet insert of high quality.

They are lighter than natural filled and more practical as they are easier to care.



Modelo	Relleño	Tamaños	
Classic Microfibra: 100 gr - 100% Pol.	Delcrón Siliconizado 100% Poliéster 150 gr & 200 gr	Individual	170 cm x 240 cm
Premium Arcus: 180 hilos 50% Alg. - 50% Pol.	Delcrón Siliconizado 100% Poliéster 200 gr & 300 gr	Matrimonial	205 cm x 240 cm
Luxury Alba: 200 Hilos 100% Alg.	Delcrón Down Alternative 100% Poliéster 200 gr & 300 gr	Queen	220 cm x 240 cm
		King	270 cm x 240 cm

*Las medidas pueden ajustarse a las necesidades del cliente.

Model	Fill	Size	
Classic Microfibra 100 gr - 100% Pol.	Siliconized Fill 100% Polyester 5 oz and 7 oz	Twin	67" x 94"
Premium Arcus 180 TC 50% Alg. - 50% Pol.	Siliconized Fill 100% Polyester 7 oz and 11 oz	Full	81" x 94"
Luxury Alba 200 TC 100% Cot.	Down Alternative Fill 100% Polyester 7 oz and 11 oz	Queen	88" x 94"
		King	103" x 94"

*Dimensions can be adjusted to the client's requirements.

Cubrecolchones Capitonado

Quilted mattress covers



Cubrecolchón con faldón
Fitted mattress protector



Cubrecolchón con elástico
Mattress protector with strings

	Tipo	Tamaños (cm)	Composición	
Cubrecolchón capitonado*	Con faldón	Individual Matrimonial Queen King	100 x 203 x 46 135 x 203 x 46 150 x 203 x 46 200 x 203 x 46	Tela: Microfibra 100% Pol. Relleno: Delcrón siliconizado 150 gr Faldón: Microfibra 100% Pol.
	Con elásticos	Individual Matrimonial Queen King	100 x 203 135 x 203 150 x 203 200 x 203	Tela: Microfibra 100% Pol. Relleno: Delcrón siliconizado 150 gr
Cubrecolchón capitonado impermeable Cumulus	Con faldón	Matrimonial Queen King	137 x 203 x 46 152 x 203 x 46 202 x 203 x 46	Tela: Microfibra 100% Pol. Respaldo: 100% Poliuretano Relleno: Fibra de Pol. 120 gr Faldón: 100% Loop Terry

*Las medidas pueden ajustarse a las necesidades del cliente.

	Type	Size (in)	Fabric	
Quilted mattress cover*	Fitted	Twin Full Queen King	39 x 79 x 18 53 x 79 x 18 59 x 79 x 18 79 x 79 x 18	Fabric: Microfiber 100% Pol. Filling: Siliconized delcron 150 gr Band: Microfiber polyester
	With Straps	Twin Full Queen King	39 x 79 53 x 79 59 x 79 79 x 79	Fabric: Microfiber 100% Pol. Filling: Siliconized delcron 150 gr
Cumulus Waterproof Quilted mattress cover	Fitted	Full Queen King	54 x 79 x 18 60 x 79 x 18 80 x 79 x 18	Fabric: Microfiber 100% Pol. Backing: 100% Polyurethane Filling: Fiber Pol. 120 gr Band: 100% Loop Terry

*Dimensions can be adjusted to the client's requirements.

Protectores de colchón impermeable

Waterproof mattress protectors



Protector de colchón con faldón
Fitted mattress protector



Protector de colchón con elástico
Mattress protector with strings

Modelo	Tipo	Tamaños (cm)	Composición
Protector de colchón impermeable Econfort Tecnocool	Con faldón	Individual Matrimonial Queen King	Econfort Tela: 80% Alg. - 20% Pol. Backing 100% Poliuretano Faldón: Poliéster microfibra
	Con elásticos	Individual Matrimonial Queen King	Tecnocool Tela: 75% Cooling 25% Pol.

Model	Type	Size (in)	Fabric
Waterproof mattress protector Econfort Tecnocool	Fitted	Twin Full Queen King	Econfort Fabric: 80% Cot. - 20% Pol. Backing 100% Polyurethane Cover: Microfiber polyester
	With Straps	Twin Full Queen King	Tecnocool Fabric: 75% Cooling 25% Pol.

Bordados

Embroidery

Para agregar un toque distintivo a su ropa de cama; nuestra línea de bordados, bies, festón y pespunte logran dar una mejor presentación y personalización a su proyecto.

Our embroidery and piping accents provide an improved aesthetic and allows you to personalize your project.



Tipos de Bordados

Types of Embroidery

Contamos con una selección de diseños de bordados a elegir y podemos desarrollar diseños especiales de acuerdo a los requerimientos del cliente.

We offer a wide selection of embroidery designs to choose from and we can work with special designs according to client's requirements.



AMBER JUNGLE



JULES GREY



CIRCLE GRIS
CIRCLE GREY



AMBER HONEY



JULES SAND



LADDER ARENA
LADDER SAND



DOBLE FESTÓN NEGRO
DOUBLE FESTOON BLACK



DOBLE FESTÓN PLATA
DOUBLE FESTOON SILVER



DOBLE FESTÓN BLANCO
DOUBLE FESTOON WHITE



TRIPLE FESTÓN BLUE
THREE FESTOON STRIPES BLUE



TRIPLE FESTÓN GREEN
THREE FESTOON STRIPES GREEN



TRIPLE FESTÓN TERRA
THREE FESTOON STRIPES TERRA



CINCO LÍNEAS FESTÓN BLUE
FIVE FESTOON STRIPES BLUE



CINCO LÍNEAS FESTÓN GREEN
FIVE FESTOON STRIPES GREEN



CINCO LÍNEAS FESTÓN TERRA
FIVE FESTOON STRIPES TERRA

Proyectos especiales

Custom projects

Royal Hideaway Playacar
Playa del Carmen





Secrets Akumal
Riviera Maya



Secrets Maroma
Cancún



Mahekal Beach Resort
Playa del Carmen



Toallas *Towels*

Ofrecemos una variedad de toallas funcionales y resistentes al lavado industrial 100% algodón de máxima absorción.

Ya sean toallas de baño, para manos, faciales, para alberca o tapetes; nosotros contamos con ellas.

We offer a variety of functional towels resistant to industrial cleaning: 100% cotton with maximum absorption.

Whether you need bath towels, hand towels, face towels, pool towels or bath mats; we have them.

La Josefina

Línea de toallas que ofrecen resistencia, suavidad, absorción y mayor durabilidad que otras toallas de su tipo.

Especialmente diseñadas y fabricadas para soportar el uso necesario que se requieren en hoteles, hospitales, spa o villas. El tejido es 100% Algodón.

Towels that offer resistance, softness, absorption and greater durability than other towels of its kind.

Specially designed and made to withstand the necessary use required in hotels, hospitals, spa or villas. Josefina's 100% Cotton fabric.



	Medidas	Color	Peso	Composición
Toalla de Baño	70 cm x 140 cm	Blanco	650 gr	100% Algodón
	80 cm x 145 cm	Blanco	770 gr	
Toalla de Mano	40 cm x 70 cm	Blanco	180 gr	
Toalla Facial	30 cm x 30 cm	Blanco	42 gr	

	Dimensions	Color	Weight	Composition
Bath towel	27½" x 55"	White	23 oz	100% Cotton
	31½" x 57"	White	27 oz	
Face towel	16" x 27½"	White	6.3 oz	
Wash towel	12" x 12"	White	1.5 oz	

Foreversoft

La línea de toallas *Foreversoft* ofrece una tecnología de tejido patentada, disponible exclusivamente en productos de tela fabricados por Standard Textile.

Utilizando tecnología de punta en optimización de rendimiento, las toallas *Centium Core* ofrecen una sensación suave, combinada con resistencia y durabilidad.

Diseñadas para ofrecer una retención de blancura excepcional y características superiores de liberación de manchas, conservan una sensación extraordinariamente suave durante su uso.

Foreversoft towels features a patented fabric technology, available exclusively on products manufactured by Standard Textile.

*Using performance optimization engineering Polymers, **Centium Core** towels offer a soft feeling, combined with strength and durability.*

Designed to offer exceptional whiteness retention and superior stain release characteristics, they retain an extraordinarily exquisite touch during every use.



A. Hilos de microfilamento sintético
A. Synthetic microfilament threads

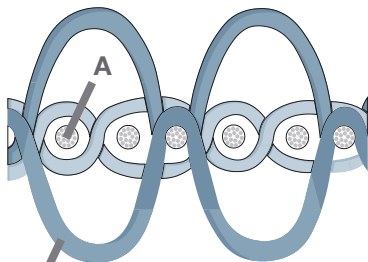

B. Hilos 100% algodón
A. 100% cotton threads

	Medidas	Color	Peso	Composición
Toalla de Baño	69 cm x 142 cm	Blanco	643 gr	55% Algodón - 45% Poliéster Centium Core
Toalla de Mano	41 cm x 69 cm	Blanco	113 gr	
Toalla Facial	33 cm x 33 cm	Blanco	57 gr	

	Dimensions	Color	Weight	Composition
Bath towel	27" x 56"	White	23 oz	55% Algodón - 45% Poliéster Centium Core
Face towel	16" x 27"	White	4 oz	
Wash towel	13" x 13"	White	2 oz	

Lynova

Sensación y tacto inigualables con la suavidad y absorbencia ideales, sus huéspedes se sentirán complacidos con nuestra línea de toallas Lynova.

Hechas con hilos 100% algodón hilado en espiral. Las toallas Lynova tienen una calidad de 5 estrellas, su tejido de doble capa cumple con todos los puntos necesarios para brindar una experiencia de lujo.

Unrivaled feeling and touch with the ideal softness and absorbency, your guests will be pleased with our Lynova towel line.

Made with 100% cotton spun threads. Lynova towels offer 5 star quality, its double layer fabric meets all the necessary points to provide an unparalleled luxurious experience.



	Medidas	Color	Peso	Composición
Toalla de Baño	69 cm x 147 cm	Blanco	680 gr	100% Algodón
Toalla de Mano	41 cm x 76 cm	Blanco	189 gr	
Toalla Facial	33 cm x 33 cm	Blanco	68 gr	

	Dimensions	Color	Weight	Composition
Bath towel	27" x 58"	White	24 oz	100% Cotton
Face towel	16" x 30"	White	6.6 oz	
Wash towel	13" x 13"	White	2.4 oz	

Toallas de alberca

Pool towels

Una amplia variedad de toallas de alberca que están diseñadas para áreas de alto tráfico.

Cada uno de nuestros modelos de toalla de alberca esta hecho para durar, y tejida para resistir numerosos lavados.

A wide variety of pool towels that are designed for high traffic areas.

Each of our pool towel models is made to last, and woven to withstand numerous washes.



	Color	Medidas	Peso	Composición
Josefina	Azul	90 cm x 190 cm	900 gr	100% Algodón
	Beige	90 cm x 170 cm	700 gr	
	Color	Dimensions	Weight	Composition
	Blue	39" x 74"	31 oz	100% Cotton
	Beige	39" x 66"	24 oz	



	Medidas	Peso	Composición
Euro Spa	89 cm x 178 cm	744 gr	100% Algodón
	Dimensions	Weight	Composition
	35" x 70"	26 oz	100% Cotton



	Medidas	Peso	Composición
Seaglass Stripe	76 cm x 152 cm	533 gr	80% COT - 20% PES
	Dimensions	Weight	Composition
	30" x 60"	18.8 oz	80% COT - 20% PES



	Medidas	Peso	Composición
Cabana Stripe	76 cm x 152 cm	515 gr	100% Algodón
	Dimensions	Weight	Composition
	30" x 60"	18 oz	100% Cotton

Complementos de baño

Bathroom complements



Bata Josefina
Josefina bath robe

Diseñada especialmente para soportar el uso que se requiere en hoteles, hospitales, spa o villas. Su tejido 100% algodón ofrece un tacto suave y un alto nivel de absorbencia.

Specially designed for the use required in hotels, hospitals, spa or villas. Its 100% cotton fabric offers a soft touch and a high level of absorbency.



Bata Waffle
Waffle bath robe

Visualmente atractiva, el cuello estilo kimono le da un toque de modernidad y el tejido confeccionado con hilos de algodón brindan la suavidad que los huéspedes buscan en una bata de baño.

Visually attractive, the kimono style collar gives it a modern touch and the cotton micro-thread fabric provides the softness that guests look for in a bathrobe.



Tapete Josefina
Josefina Rug

Medidas	Color	Peso	Composición
55 cm x 90 cm	Blanco	400 gr	100% Algodón

Dimensions	Color	Weight	Composition
21" x 35"	White	14 oz	100% Cotton



Tapete Eurosoft
Eurosoft Rug

Medidas	Color	Peso	Composición
50 cm x 76 cm	Blanco	263 gr	86% Algodón 14% Poliéster

Dimensions	Color	Weight	Composition
20" x 30"	White	9 oz	100% Cotton 14% Polyester



Mantelería
Table linen

Sin importar el color o el patrón, un mantel y los accesorios correctos pueden transformar la decoración de cualquier mesa. De algodón, mezcla de algodón y poliéster o 100% poliéster, ofrecemos una amplia variedad de opciones de telas y colores.

Nuestra estupenda gama de mantelería cuenta con características como resistencia a las manchas y alta solidez al color, todas las telas pueden lavarse a máquina.

Mezcle y combine nuestros tejidos lisos con nuestras telas texturizadas para crear una apariencia única.

No matter the color or pattern, the right linen can transform the décor of any table. From cotton, cotton blend to 100% polyester, we offer a wide variety of fabrics and color options.

Our range of tablecloths has features such as stain resistance and high solid colors that can be machine washed.

Mix and match our fabrics to create a unique look.

Caminos de mesa

Table runners

Decorativo textil que se coloca al centro de la mesa estilizandola y brindando un ambiente de calidez al comensal.

Decorative element made of fabric that is laid on top of tablecloths or on a bare table. They are used to define seating or used to carry out a decoration theme.



Medidas

	30 cm x 100 cm
Camino de mesa	30 cm x 128 cm
	30 cm x 154 cm

Dimensions

	12" x 39"
Table runner	12" x 50"
	12" x 60"

Manteletas

Placemats

Elemento decorativo que sirve para delimitar el espacio del comensal y al mismo tiempo le otorga un toque de estilo a la mesa.

A decorative element that is used to delimitate a diner's space, and also gives the table a touch of style.



	Medidas
Manteleta	50 cm x 36 cm

	Dimensions
Placemat	20" x 14"

Servilletas

Napkins



	Medidas
Servilleta	49 cm x 49 cm

	Dimensions
Napkin	19" x 19"

Manteles

Tablecloths

Pieza de tela que cubre una mesa durante la comida y protege o decora. Nuestra gama incluye manteles cuadrados, redondos y rectangulares.

A piece of fabric that covers a table during a meal that protects and decorates. Our range includes square, rectangular and round tablecloths.



Mantel cuadrado
Squared tablecloth



Mantel rectangular
Rectangular tablecloth



Mantel circular
Rounded tablecloth

Medidas

Mantel cuadrado

100 cm x 100 cm
128 cm x 128 cm
154 cm x 154 cm
180 cm x 180 cm
206 cm x 206 cm
261 cm x 261 cm

Mantel rectangular

128 cm x 180 cm
128 cm x 206 cm
128 cm x 261 cm
128 cm x 314 cm

Mantel circular

150 cm
176 cm
257 cm
310 cm

Dimensions

Squared tablecloth

39" x 39"
50" x 50"
60" x 60"
81" x 81"
79" x 79"
103" x 103"

Rectangular tablecloth

50" x 71"
50" x 81"
50" x 103"
50" x 124"

Rounded tablecloth

59"
69"
101"
122"



Av. García Lavín Plaza Bon Amí
Local 4.
Col. San Antonio Cucul Mérida,
Yucatán

Tel: 999.948.96.36

Cel:999.117.95.36

www.mueblesmerida.com

ventas@mueblesmerida.com

